

You think
WE MEASURE

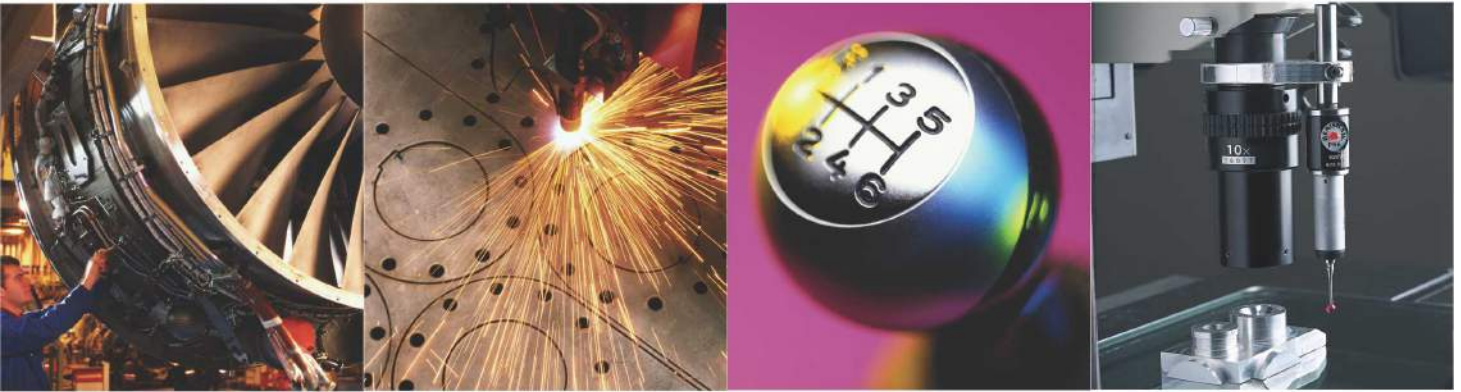

For Your All Dimensional Measurement Problems



Vision Measuring Systems

Co-ordinate Measuring Machines

One Click Measurement Solutions

SIPCON INSTRUMENT INDUSTRIES



Making Quality To MEASURE Quality

Established in 1971 as Industrial division **SIPCON** having more than **35** years of experience has laid a firm foundation of expertise and excellence on which all Specialist and Engineers rely for optimum efficiency and total reassurance.

In extending its sphere of influence in the field of optical metrology **SIPCON** offers a comprehensive and superior lineup of quality **Profile Projectors, Vision Measuring Systems, Industrial Vision Inspection Solutions and Coordinate Measuring Machines** - the largest range in the world.

The International standard calibration system assures highest level of accuracy with International and NPL traceability. With a network of fully trained marketing agents **SIPCON** provides full after sale service and support second to none. The name **SIPCON** stands synonymous with the ultimate in precision, quality and reliability. It can be said that **SIPCON** products are PAR Excellence i.e Excellence in **PRECISION, ACCURACY & RELIABILITY**



SPN-300
Profile Projector



SDM-QC
Depth Measuring Microscope



ISO 9001:2008 certified organization



CE Approved Product Range

SINCERITY QUALITY INNOVATION SERVICE

PERFECTION CUSTOMER SATISFACTION PROACTIVE

ZERO - DEFECTION TECHNIQUE TRANSPARENCY



Tool INSPECTOR

Application for the measurement of
Drilling side milling cutter, end mill and special cutters

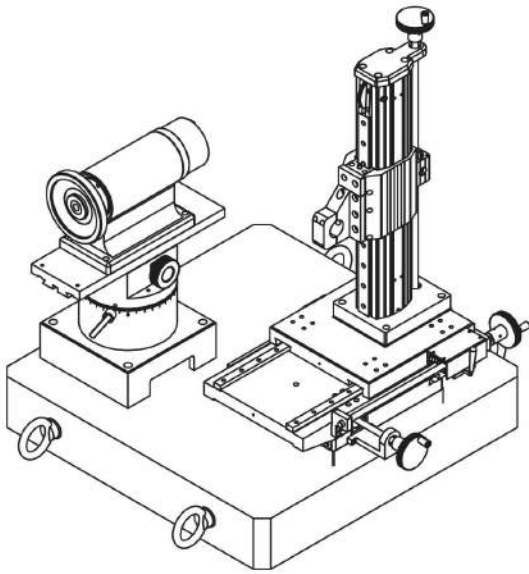

Applications:

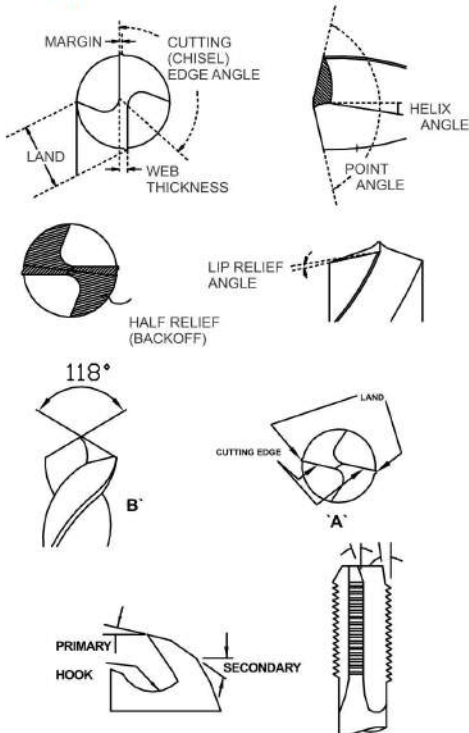

SPECIFICATIONS :-

Model No:	SVI-TI-3D	SVI-TI-5300
Software	MSU-3D Pro	QC-5000
Measuring Range	150mm X 100mm X 200mm (X, Y, Z)	
Resolution	0.005 / 0.001 / 0.0005 mm	
Linear Accuracy	(3+L/200) micron	
Repeatability	+/- (0.002mm)	
Vision	1/3" High Resolution CCD Camera	
Magnification	Optical Magnification 0.7x - 4.5x	
Video Edge Detection	Standard	
Optional Hardware	PC P4 + 17" TFT Monitor	
Illumination Surface	LED	
Operation	Manual with Quick Release Knob	
Base Platform & Column	Granite / Metal Base	
Turret	Rotary Table with 120° Gonio Meter	
Power Supply	220-240 V +/- 5%, 50/60 HZ	
Co Axial illumination	Optional	



VISION MEASURING SYSTEM SVI-IMG SERIES



SVI-IMG -300

- Highly **Precise** Metal **Base And Column**
- Superior Measurement **Accuracy** And **Repeatability** For Tight Tolerance Application.
- Automatic **Video Edge Detection**.
- **High Resolution** Parafoveal Zoom LENS.



SVI-IMG -3D



SVI-IMG -5300

- Flat Field **High Resolution Optics** For Sharp Uniform Images.
- **Unmatched Illumination** Flexibility For Difficult Measurements.
- **Powerful, Flexible Software** For Programmability.
- **Advanced Mechanical Design** Resulting In High Speed & Accuracy.
- Manual Operation With Quick-moving Stage.



VISION MEASURING SYSTEM

SVI-IMG SERIES

SPECIFICATIONS :-

Model No:	SVI-IMG-300	SVI-IMG-3D	SVI-IMG-5300
Software	QC-300	MSU-3DPro	IK 5000
Measuring Range - Standard	150mm X 100mm X 100mm		
Measuring Range - Optional	X-Axis upto 500mm, Y-Axis upto 400mm, Z-Axis upto 300mm		
Resolution	0.005 / 0.001 / 0.0005 / 0.0001mm		
Linear Accuracy	(3+L/200) micron		
Repeatability	+/- (0.002mm)		
Vision	1/3" High Resolution CCD Camera		
Magnification	Optical Magnification 0.7X - 4.5X & Magnification on Monitor 35X - 225X		
Video Edge Detection	Standard		
Optional Hardware	PC + 19" TFT Monitor		
Illumination Surface	Fibre Optic / LED		
Illumination Contour	Halogen Lamp / LED		
Operation	Manual with Quick Release Knob		
Base Platform & Column	Metal Base		
Platform load capacity	15 kg		
Power Supply	220-240 V +/- 5%, 50/60 HZ		
Motion Control through Joystick	Optional		
Programmable Light Control	Optional		
Touch Probe	Optional		
Non-Linear Error Correction	Optional	Standard	Optional
AutoFocus	Optional		

Options

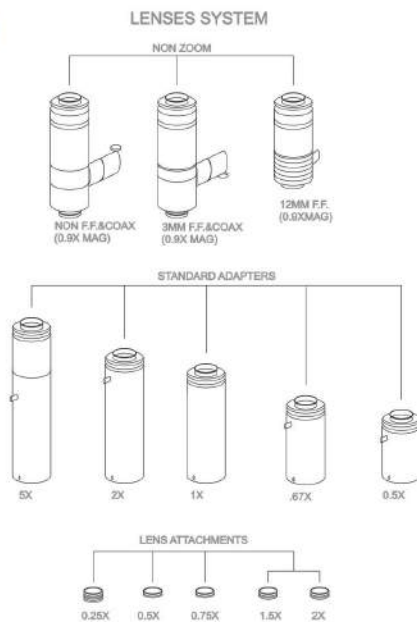

Surface Illumination



L.E.D.



Fibre Optic

Motion Control Through Joy Stick



Touch Probe





Multi SENSOR CNC INSPECTION SYSTEM

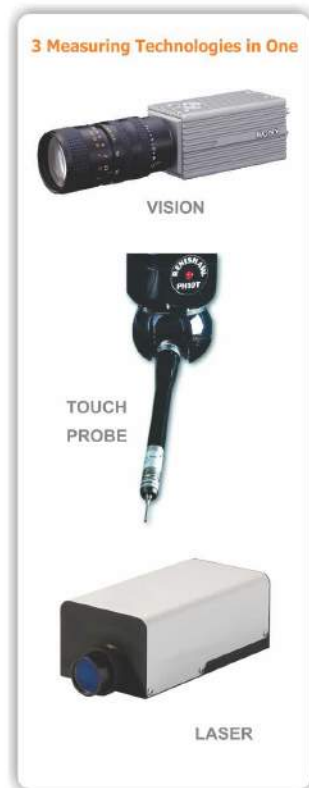

SVI-5300-CNC-VT

VISION



- **Highest Through Put** In Flat Non Contact Measurement.
- **Most Accurate Microscopic** Parts Measurements
- Quick To Capture Even The **Smallest Details**

TOUCH PROBE



- **Best Solution** For 3d Measurements
- **Perfect Solution** Non Pliable Parts
- Applications Includes 3d Measurements Of Metal Processed Parts Like **Apertures, Included Angle** Etc.

LASER



- Highest Accuracy Is **Depth Measurement**
- Best For **Surface Contouring** And **Surface Scanning**
- Applications Include **Complex Contouring** Of Mould And Measurement Of Soft And Flexible Components.



Multi SENSOR CNC INSPECTION SYSTEM

SPECIFICATIONS :-

Model No:	SVI-5300-CNC-V	SVI-5300-CNC-VT	SVI-5300-CNC-VTL
Software	IK 5000 / MSU3DPRO		
Measuring Range-Standard	250 X 150 X 200 mm		
Measuring Range-Optional	X-Axis upto 500mm, Y-Axis upto 400mm, Z-Axis upto 300mm		
Resolution	0.005 / 0.001 / 0.0005 / 0.0001mm		
Linear Accuracy	(3+L/200) micron		
Repeatability	+/- (0.002mm)		
Vision	1/3" High Resolution CCD Camera		
Magnification	Optical Magnification 0.7X - 4.5X & Magnification on Monitor 35X - 225X		
Video Edge Detection	Standard		
Optional Hardware	PC + 19" TFT Monitor		
Illumination Surface	Fibre Optic / LED		
Illumination Contour	Halogen Lamp / LED		
Operation	Manual with Quick Release Knob & CNC		
Base Platform & Column	Granite		
Platform load capacity	30 kg		
Power Supply	220-240 V +/- 5%, 50/60 HZ		
Motion Control through Joystick	Standard		
Programmable Light Control	Optional		
Non-Linear Error Correction	Optional		
Autofocus	Optional		
Touch Probe	X	Renishaw MCP / MH20i	Renishaw MCP / MH20i
Laser Probe	X	X	Conoprobe

Options

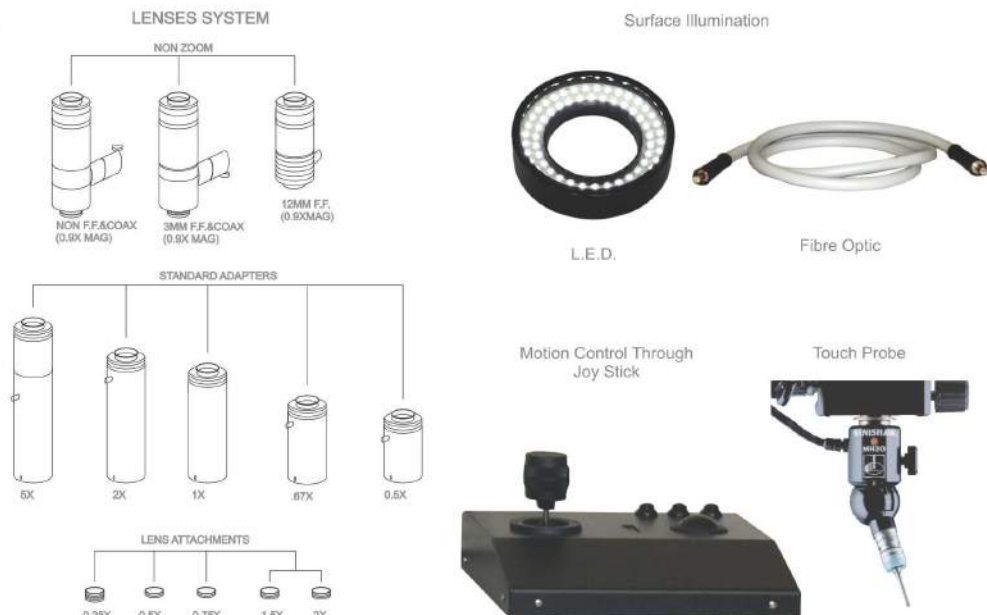



OPTICAL COORDINATE MEASURING MACHINE (OCMM)



SVI-OCMM-442

- Granite table confirming to DIN 876 standards ensure **perfect flatness of the table.**
- **Powerful, flexible software** for programmability and flexibility.
- **Automatic Video Edge Detection.**
- **High Resolution** Parafoveal zoom lenses.
- Hollow **Z-axis structure** reduces distortion of its own.
- **Advanced mechanical design** resulting high speed & accuracy.
- **Drive systems** provide faster and better motion capability.
- Highly suitable for large size **PCB inspection or sheet metal components.**
- Flat field **High Resolution Optics** for sharp uniform images.
- **Unmatched illumination** flexibility for difficult measurements.
- Options of **Touch probe** and **Laser probe** improves the 3d measuring capabilities of the machine.



Optical COORDINATE MEASURING MACHINE (OCMM)

SPECIFICATIONS :-

Model No:	SVI-OCMM-442	SVI-OCMM-662	SVI-OCMM-10122
Measuring Range	450 X 450 X 200	600 X 600 X 200	1000 X 1200 X 200
Linear Accuracy U1	3+L/200 μ m	3+L/200 μ m	5+L/200 μ m
U2	5+L/150 μ m	5+L/150 μ m	6+L/150 μ m
Magnification	Optical Magnification 0.7X - 4.5X & Magnification on Monitor 35X - 225X		
Software	IK 5000		
Resolution	0.005 / 0.001 / 0.0005/ 0.0001 mm		
Repeatability	+/- (0.003mm)		
Transmission	Linear Guide way + Rolling Drive Nut		Air Bearing
Vision	1/3" High Resolution CCD Camera		
Video Edge Detection	Standard		
Optional Hardware	PC + 19" TFT Monitor		
Illumination Surface	Fibre Optic / LED		
Illumination Contour	Halogen Lamp / LED		
Operation	Manual with Quick Release Knob / CNC		
Base Platform & Column	Granite DIN 876 Grade 0		
Power Supply	220-240 V +/- 5%, 50/60 HZ.		
Motion Control through Joystick	Optional		
Programmable Light Control	Optional		
Touch Probe	Optional		
Non-Linear Error Correction	Optional		
Platform load capacity	20 Kgs Optionally upto 50 Kgs		
Machine Dimensions	1500 X 1150 X 1650mm	1800 X 1700 X 1700mm	2000 X 2200 X 1800mm

Note : Other size specifications can be provided on request. (1000x1000x200 and 1200 X 1500 X 200)

Options

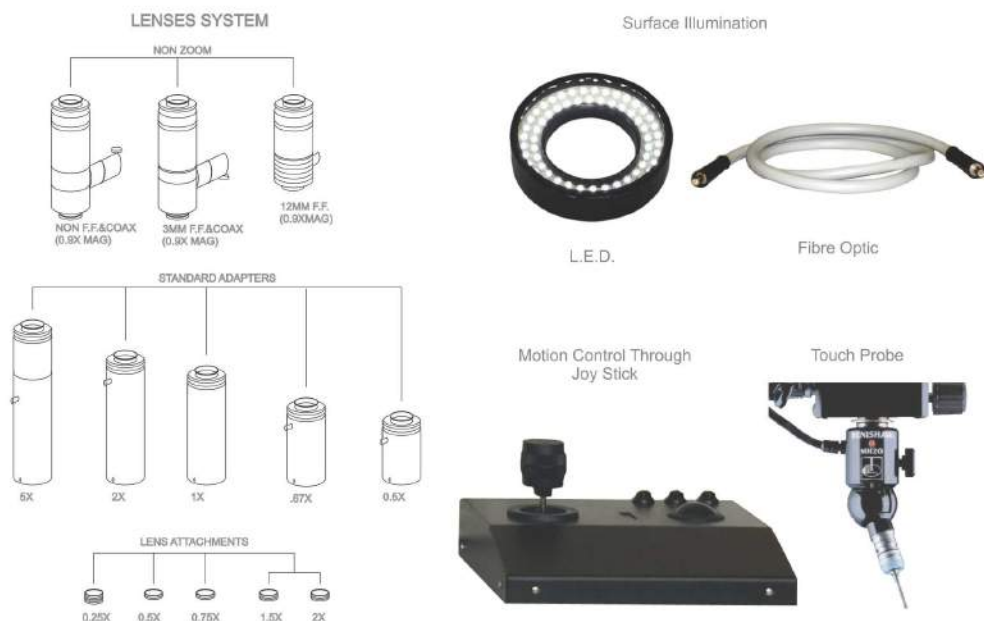



Co-ORDINATE MEASURING MACHINE CMM

SVI-CMM-554



SVI-CMM-775



SVI-CMM-442



Co-ORDINATE MEASURING MACHINE CMM

SPECIFICATIONS :-

Model No:	SVI-CMM-442	SVI-CMM-554	SVI-CMM-775	SVI-CMM-8106
Measuring Range	400 X 450 X 250	500 X 500 X 400	700 X 700 X 500	800 X 1000 X 600
Linear Accuracy U1	2+L/200 µm	1.5+L/200 µm	1.5+L/200 µm	1.5+L/200 µm
MPE _z U3	4+L/100 µm	3+L/200 µm	3+L/200 µm	4+L/150 µm
Maximum Part Weight	120 Kgs / 200 Kgs	150 Kgs / 500 Kgs	200 Kgs / 700 Kgs	800 kgs / 1000 Kgs
Maximum Part Height	250 mm	400 mm	500 mm	600 mm
Transmission	Linear Guide way + Drive nut	Air Bearing in 3 axis	Air Bearing in 3 axis	Air Bearing in 3 axis
Software	IK 5000 / MSU3DPro			
Resolution	0.001 / 0.0005/0.0001 mm			
Repeatability	By Ring Gauge (0.003mm)			
Optional Hardware	PC + 19" TFT Monitor			
Operation	Manual or CNC			
Base Platform & Column	High Precision Granite DIN 876 Grade 0			
Power Supply	415-430 V + /- 5%, 50/60 HZ			
Touch Probe	Renishaw MCP / MH-20 /MH20i / PH10T / PH10M / PH10MQ / PH2Q			
Z-axis Balance	Counter Weight / Air Cylinder			
Vision	1/3" High Resolution CCD Camera (Optional)			
Magnification	Optical Magnification 0.7X - 4.5X & Magnification on Monitor 35X - 225X			
Motion Control through Joystick	Optional			

* Accuracy is defined with master gauges at temperature 20⁰ C ±1⁰ C and humidity 55% to 65%

Note: Machine Size and Weight load capacity modified to 1200mm & 1000Kgs respectively.

- Highly precise & stiff **air bearing technology improves** motion precision of the machine.
- **Granite table** conforming to din 876 standards ensure **perfect flatness of the table.**
- **Accurate drive systems** provide faster and better motion capability.
- **Hollow z-axis structure** reduces distortion of its own.
- Options of **vision probe and laser probe** improves the speed and measuring capabilities
- **Advanced mechanical design** resulting in **high speed & accuracy.**





SPECIAL PURPOSE MICROSCOPES



Available in both **MANUAL**
& **CNC** VERSIONS
Fully VERSATILE **High Precision**
MEASURING MICROSCOPE
"SIPCON"
Allows **NON-CONTACT,**
High Precision depth (STEP)
MEASUREMENTS THROUGH
High RESOLUTION
PARAFOCAL ZOOM LENS

SPECIFICATIONS :-

OPERATION	MANUAL/CNC	
Model No:	SDM -TRZ-3D	SDM-TRZ-5300
Software	MSU-3DPro	IK 5000
Observation Head	Binocular/Trinocular	
Optical -Magnification	0.7X, 1X, 2X, 3X, 4X, 4.5X	
Magnification on Monitor	35X -225X	
Eyeiece	WF-10X with Cross Hair / Optionally 20X/25X	
Magnification on eye piece	7X, 10X, 20X, 30X, 40X, 45X	
Optional	50X, 100X, 200X, 400X, 500X, 1000X, 1200X, 1500X	
Measuring Range	150mm X 100mm X 100mm	
Measuring Range - Optional	X-Axis upto 500mm, Y-Axis upto 400mm, Z-Axis upto 300mm	
Resolution	0.005 / 0.001 / 0.0005 / 0.0001mm	
Linear Accuracy	(3+L/200) micron	
Repeatability	+/- (0.002mm)	
Vision	1/3" High Resolution CCD Camera	
Optional Hardware	PC P4 + 17" TFT Monitor	
Illumination Surface	Fibre Optic / LED / Co-axial	
Illumination Contour	Halogen Lamp / LED	
Operation	Manual with Quick Release Knob / CNC	
Base Platform & Column	Metal Base / Granite Base	
Platform load capacity	15 Kgs / 25 Kgs	
Power Supply	220-240 V +/- 5%, 50/60 HZ	
Touch Probe	Optional	
Laser	Optional	



DEPTH MEASURING MICROSCOPE

Fully Versatile **High Precision**

MEASURING MICROSCOPE

“SIPCON”

Allows Non-Contact,

High Precision **depth (step)**

MEASUREMENTS THROUGH

simple OPERATION

while OBSERVING

THE SURFACE OF A POINT

OF MEASUREMENT.



**SDM UNIVERSAL
MEASURING MICROSCOPE**

Model No:	SDM -TR-3D	SDM-TR-5300
Software	MSU-3DPro	QC-5300
Observation Head	Binocular/Trinocular	
Objective -Standard	1X, 3X and 5X	
Objective Optional	10X / 40X / 45X / 60X	
Eye-piece	WF-10X with Cross Hair	
Magnification on eye piece	10X, 20X, 30X, 50X	
Optional	100X, 200X, 400X, 500X, 1000X, 1500X	
Measuring Range	150mm X 100mm X 100mm	
Measuring Range Optional	Upto 500/400/300mm for X/Y/Z-Axis resp.	
Resolution	0.005 / 0.001 / 0.0005 / 0.0001mm	
Linear Accuracy	(3+L/200) micron	
Repeatability	+/- (0.002mm)	
Vision	1/3" High Resolution CCD Camera	
Optional Hardware	PC + 19" TFT Monitor	
Illumination Surface	Fibre Optic / LED / Co-axial	
Illumination Contour	Halogen Lamp / LED	
Operation	Manual with Quick Release Knob / CNC	
Base Platform & Column	Metal Base	
Platform load capacity	15 kgs / 25kgs	
Power Supply	220-240 V +/- 5%, 50/60 HZ	
Touch Probe	Optional	

Applications : Highly appreciated by manufacturers for its accurate measurements and inspection of objects such as:

- Depth of Metallic Mold.
- Strain of Lead Frame.
- Height of Bonded portion of lead wire
- Wafer bump height
- Height of lead frame
- Height of Solder
- Projection of Head on the VTR Drum.
- Step of Hybrid IC.
- Terminal Steps on Multi Layer PC Boards
- Recess on the Can.



MEASURING SOFTWARE

MSU 3D PRO

"THE MEASURING SOFTWARE PROVIDES A QUICKER AND EASIER MEASURING METHOD. 3 AXIS GEOMETRICAL MEASURING FUNCTIONS, AUTOMATIC EDGE DETECTION AVOIDS VISION MISTAKES AND TIREDNESS. EXCELLENT GRAPHICS INTERFACE ALLOW TRANSFER TO CAD"

Software Desktop

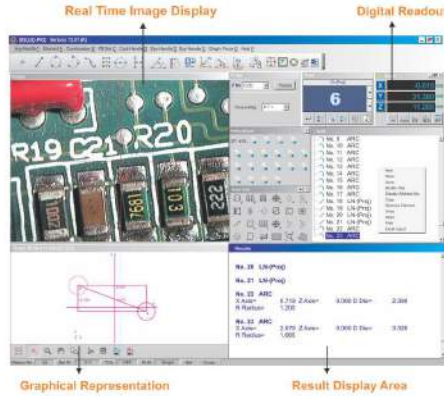

Fast Multi Datum Output

You can do more than one measurement at the same time by setting the options in this window. For example you are measuring the distance between the two circles and at the same time you want the angle of the distance line with the X axis just set the options, you will get both result with just one click.

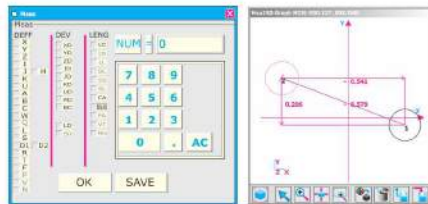

Data Management - Export

Option to save graphs as DXF or IGS files makes it possible to export our measurements to CAD and CAM for further editing. You can also "click" the features in the graph to calculate the measurements between the elements. For example to measure the distance between the 2 circles in the graph just click the distance button and then click the two circles from the graph. The result is on the screen.....

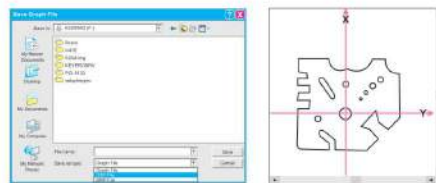

Program Hot key Board

Customize the series of measurements according to your part and make an icon for it. Next time just press it and start the measurement. So with this software just Measure one part for the others it will guide you how to measure.

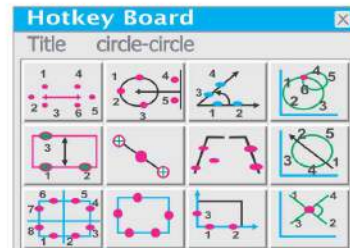

MS- Excel Report Generator

Just right click on the result display and transfer all the results with graphic display to MS-Excel in a fully customizable report format with coded Pass / Fail for tolerance parts and get reports conforming to your ISO specifications.



Light Control

Software capable of handling 4 channel light controller with programming capability for each channel i.e. intensity value for each channel source would be memorized in the program and would be repeated at the time of running. This can also be used to control the 4 Quadrant LED light controller.





MEASURING SOFTWARE MSU 3D PRO

"TYPICAL WORK
PIECES
CONTAINING
MULTIPLE
EDGES
WITH IN
CALIPER OR
WEAK
CONTRAST
MAKES
EDGE
DETECTION
EXTREMELY
DIFFICULT.
MSU3DPro IS
EXTREMELY
POWERFUL
IN
SHARPENING
IMAGES
AND
ENHANCING
THE
PRECISION."

Tolerance Setting & Result Display

Supports more than 10 types of Tolerance setting including group Tolerancing (Circularity, Concentricity, Perpendicularity, Parallelism etc....) and Result window will display all the results with tolerance values and will give an indication for PASS or Fail features.



Focus Indicator for accurate 3-D Measurement

This will indicate the best focus value and the corresponding Z value to make sure focus is clear before measurement. A must to do for 3-D Measurement.

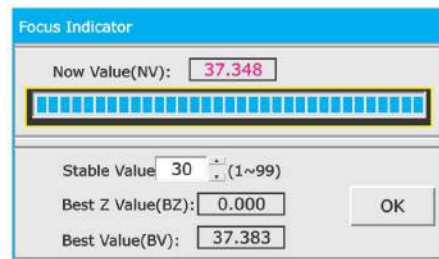

Programming & Navigation

Teach programs with one click and repeat those with the help of navigation Tool bar shown in the above picture. This navigation Toolbar guides you what features are to be measured and where is there exact location – Just press the mouse clicks and complete part will be measured. So just measure one part other similar ones would be measured automatically.

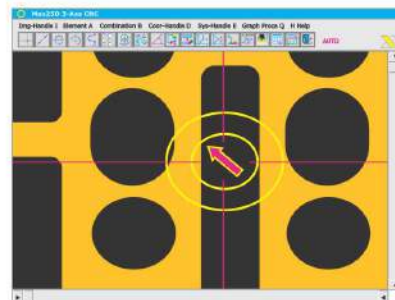

Video Edge detection measurement options

These tools automatically generates the region of interest around the feature to be measured which facilitates searching of points, lines, circles and arcs of the workpiece in that region.

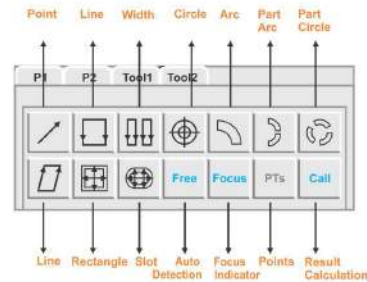

Construction capabilities

Select two or more features to create intersections or constructions. This reduces operator effort by eliminating confusing construction menus.

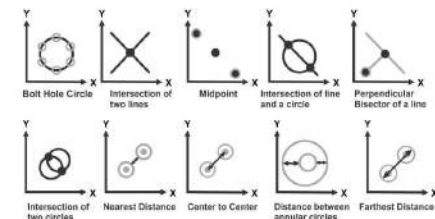

Click & Measure Top Menu Bar

One Click Menu bar for all geometric measurement, origin setting, axis alignment, MS-excel output & Programming.

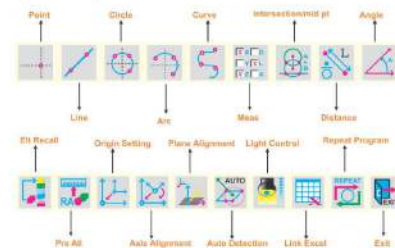

Deviation analysis of point data.

This feature gives you the coordinates of the points taken on the element along with the form tolerance value of each point. This is very useful to analyze the irregularities on the feature. You can choose the type of result you want – Min, Max or Avg. Also you can have a print out of this report.

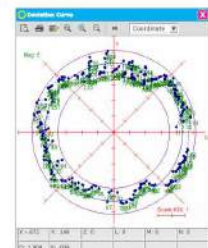



MEASURING SOFTWARE QC-5000

"THE CONCEPTUAL THE MODEL OF QC 5000 SOFTWARE ORGANIZES THE WORK FLOW TO SUPPORT OPERATOR NEEDS AT EVERY STAGE OF MEASUREMENT PROCESS-MEASURING-RECORDING-ANALYZING-REPORTING AND COMMUNICATING THE DIMENSIONAL DATA."

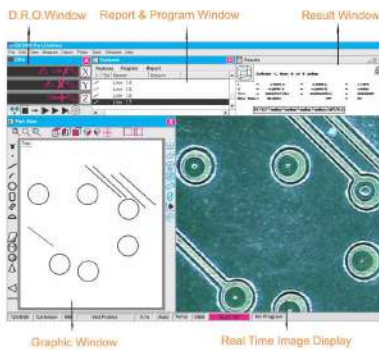

Software Desktop

Comprehensive Software Desktop with all the measuring functions just a click away. Simultaneously with the measurement you will have the result display and drawing of the measurement in front of you on the software desktop. The core of product is the simple, visual part view window with convenient tool bars that define Quadra -Chek measurement process.

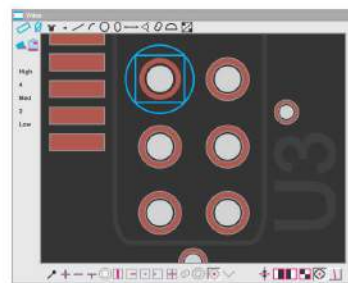

Pattern Finder

The Pattern Finder probe is used to teach and later to find features having regular or irregular patterns. Pattern finding is usually included in programs to minimize operator interaction when a datum is created automatically for each of a series of parts or when some feature locations are not repeatable due to part variations.

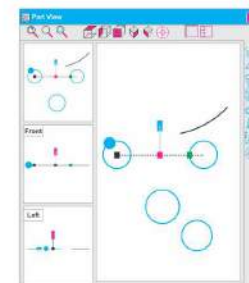

Graphical Representation

Graphical Representation in all the possible views-Top, Left, Front, South east etc. The graph is fully interactive for fast constructions and relationships. For example, to measure the distance between two circles, just select the distance function, then click on two circles in part view window. There's your answer. It's that simple.



Worm tool

The worm probe generates a series of scans perpendicular to and across the perimeter of a feature edge in the direction indicated by the probe. Each scan acquires a data point at the edge of the Image.

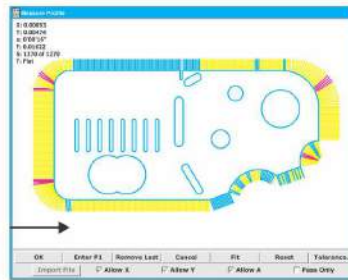

Overlap Deviation Analysis

The profile feature shown in the Feature Stamp window with form error whiskers that passed tolerance tests in the range of 0 to 50% shown in green, 51 to 100% in yellow. Form errors that fail the tolerance tests are shown in red.

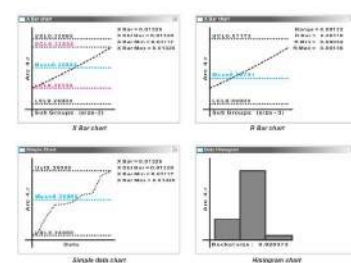

Integrated Statistical Process Control

Integrated Windows - based SPC Analysis capable of forming X Bar Chart, R Bar Chart, Simple Data Chart, Histogram & other pertinent capability & process control data.



MEASURING SOFTWARE QC-5000

"THE METROLOGY SOFTWARE FEATURES & EASY TO USE PROGRAMMING INTERFACE THAT IMPROVES PRODUCTIVITY REDUCE SUBJECTIVITY AND SIMPLIFIES REPETITIVE TASKS. CONSTRUCTION FEATURE REDUCES OPERATOR EFFORT BY ELIMINATING CONFUSING CONSTRUCTION MENUS."

Construction capabilities

Select two or more features to create intersections or constructions. Reduces operator effort by eliminating confusing construction menus.

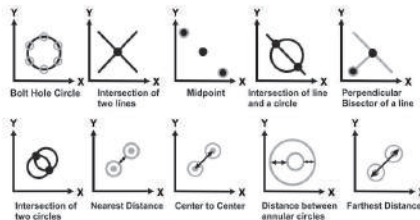

Palletizing function

A palette is a rectangular arrangement of identical parts organized into a consistent matrix of columns and rows. Once a part program is created and tested for a single part, it can be run on each of the identical parts contained in a palette.



Video Edge Detection Tools

A wide variety of video probes is available for measuring regular geometric features such as points, lines, arcs, circles and slots. Video probes are also available for measuring irregular features, features that extend beyond the field of view and entire part profiles. In addition, pass/fail charts can be imported and used to facilitate visual inspections.

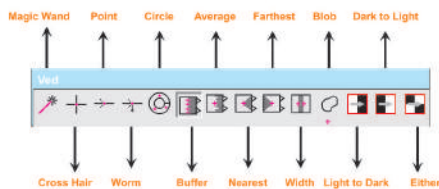

Measurement Toolbar

One click options to measure all types of 2D & 3D features. With patented feature Measure Magic probe any feature, enter points and with a click QC-5000 **knows without you telling it** whether you are measuring circle, arc, or another shape.

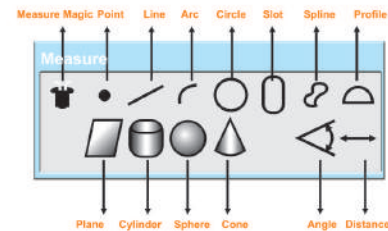

Programming

Simplify difficult and repetitive measurement sequences with an easy to use and robust programming interface. Programming steps are in English language which are easy to understand and edit. Edit any step, add any step, use normal conditional statement like if-then, else-then & lots more..

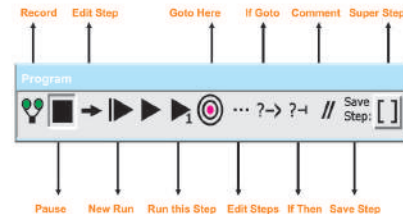

Edge teaching algorithms for weak edges

The edge teaching criterion entered by the system is adequate to provide excellent edge recognition for most applications. The criterion for the selected edge algorithm can be changed by entering a new value into the Min Contrast field. This will ensure optimum edge detection even in low contrast surfaces and exact points on the edges will ensure exact results.

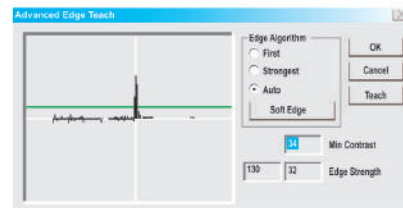



PART-QUICKIE

The One Click MEASUREMENT SYSTEM

"THE CONCEPTUAL MODEL OF SOFTWARE ORGANIZES THE WORK FLOW AT EVERY STAGE OF MEASUREMENT PROCESS - MEASURING-RECORDING ANALYZING - REPORTING AND COMMUNICATING THE DIMENSIONAL DATA."



SVI-PQ-V8060
PART-QUICKIE
(VERTICAL)

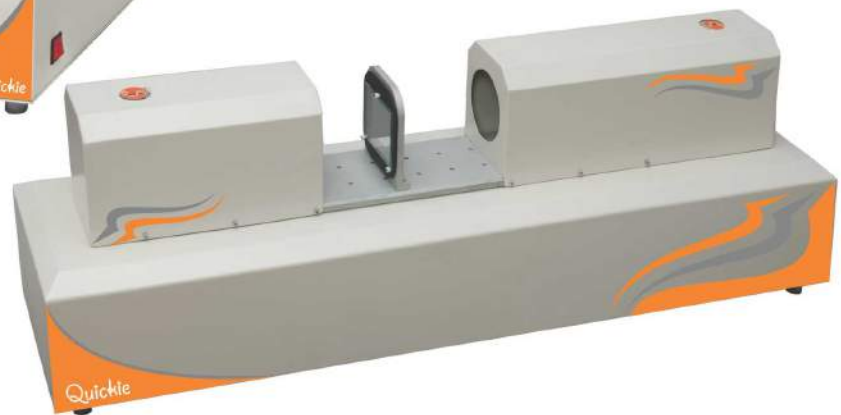

SVI-PQ-H8060
PART-QUICKIE
(HORIZONTAL)

FEATURES AT A GLANCE

- ▶ Point
- ▶ Line
- ▶ Angle
- ▶ Distance
- ▶ Radius/Diameter
- ▶ P.C.D
- ▶ Blobs
- ▶ 2D Profiles
- ▶ Area, Perimeter
- ▶ Form Tolerance
- ▶ Orientation Tolerances
- ▶ Trend Analysis
- ▶ Position Tolerances
- ▶ Deviation Analysis
- ▶ Customized Report Generation
- ▶ Construction Capabilities
- ▶ Auto Part Alignment
- ▶ Width

Technical Specifications

Model	SVI-PQ-36	SVI-PQ-64	SVI-PQ-240
Field of View	Fixed:36x27 mm	Fixed:64x48 mm	Variable from 40x30 mm to 4x3 mm
Accuracy	± 5µm	± 5µm	± 3µm
Repeatability	± 3µm	± 3µm	± 2µm
Illumination-Surface	LED	LED	LED
Illumination-Countour	Green LED	Green LED	Green LED
Z-axis Movement	30 mm	30 mm	30 mm
Power Supply	110/220V @ 50Hz ± 5%		
Max. Component Weight	3 Kg (Vertical Model) or 7 Kg(Horizontal Model)		
Machine Weight	25 Kg		
Interface	USB/Ethernet		
Optional Hardware	Laptop with Win7/8 Operating System		
Camera	5MP SONY Industrial Camera		
Base Platform & Column	Metal		
Setup	Horizontal/ Vertical		
Quick Manual Measurement	Optional		
Auto Alignment	360° Compensation		
Max. Measurement Points	10,000		

You think

WE MEASURE



SIPCON INSTRUMENT INDUSTRIES

116-B, HSIDC, Industrial Estate, Jagadhri Road, Ambala Cantt - 133 006, Haryana (INDIA)

Ph.: 0091-171-2699668, 2699344 Fax 0091-171-2699667

info@sipconinstrument.com www.sipconinstrument.com
