



TESA
TECHNOLOGY

Instruction manual

HEIGHT GAUGES

for MICRO-HITE (MH)

for MICRO-HITE+M (MH+M)



This document is confidential and only to be used internally by the company that has purchased one of the height gauges mentioned above. Before duplicating or transmitting it to third parties without any connection to the use of these instruments, an official request has to be sent to TESA SA.

TABLE OF CONTENTS

 If you are using the PDF version of this document, you can directly access the required chapter by clicking on the respective line of the table of contents.

- 1 INTRODUCTION7**
 - 1.1 Acknowledge-ments7
 - 1.2 Warning7
 - 1.3 Copyright (document)7
 - 1.4 Copyright (software)7
 - 1.5 Preamble7
 - 1.6 Symbols8
- 2 PRESENTATION.....9**
 - 2.1 General description9
 - 2.2 Instrument base11
 - 2.3 Air cushion11
 - 2.4 Vertical column.....12
 - 2.5 Rotary control handle13
 - 2.6 Handwheel15
 - 2.7 Lever-type locking ring15
 - 2.8 Electric power supply16
 - 2.9 Measuring system16
 - 2.10 Control panel18
 - 2.11 Fixing arm18
 - 2.12 Information LED19
 - 2.13 Interface & displayed values19
 - 2.14 Printer.....19
 - 2.15 Connectors20
- 3 TECHNICAL SPECIFICATIONS.....21**
- 4 DELIVERY CONTENTS22**
 - 4.1 System components22
 - 4.2 Packaging22
 - 4.3 Fine adjustment system23
 - 4.4 Calibration certificate23
- 5 INSTALLATION, SECURITY & MAINTENANCE.....27**
 - 5.1 Location.....27
 - 5.2 Place of use27
 - 5.3 Lighting.....27
 - 5.4 Measuring surface27
 - 5.5 Cleanliness.....27
 - 5.6 Vibrations27
 - 5.7 Electric power supply27
 - 5.8 Batteries28
 - 5.9 Final use.....29
 - 5.10 Storage.....29
 - 5.11 Cleaning29
 - 5.12 Opening elements29
- 6 INSTALLATION30**
 - 6.1 Packaging30
 - 6.2 Unpacking & installation.....30
 - 6.3 Installation of the printer.....38
 - 6.4 Installation of the foot switch39

7	CONTROL PANEL	40
7.1	General description	40
7.2	Touchscreen	40
7.3	Measurement zone	41
7.4	Calculation zone	42
7.5	Software navigation	42
7.6	Context-based actions	43
8	MEASUREMENT INTERFACE	44
8.1	Status bar	44
8.2	Main zone	44
8.3	Measuring force	45
8.4	Context-based actions bar	45
8.5	Measurements list	45
8.6	Location	46
9	SYSTEM OPTIONS	48
9.1	Access	48
9.2	System configuration	48
9.3	Measurement parameters	49
9.4	Bore/axis, groove/rib measurement	50
9.5	Input/Outputs	52
9.6	Tolerances	53
9.7	Temperature	54
9.8	Results and reports	54
9.9	Languages	55
9.10	Customised language	55
10	INITIALISATION	56
10.1	Concept	56
10.2	Automatic process (MH+M)	56
10.3	Manual process (MH)	56
11	DETERMINATION OF THE PROBE CONSTANT	58
11.1	Masterpiece	58
11.2	Concept	58
11.3	Procedure	60
11.4	Steps	60
12	PRINCIPLES OF MEASUREMENT	63
12.1	Generality	63
12.2	Probe support	63
12.3	Measurement modes	63
12.4	ST1 & ST2 philosophy	64
12.5	Measurement functions	65
12.6	Manual single probing (MH)	67
12.7	Automatic single probing (MH+M)	69
12.8	Static culmination point (MH), bar graph	70
12.9	Static culmination point (MH), galvanometer	74
12.10	Static culmination point (MH), help LED	76
12.11	Bore measurement, static mode (MH)	78
12.12	Dynamic culmination point (MH)	78
12.13	Bore measurement, dynamic mode (MH)	80
12.14	Culmination point (MH+M)	80
12.15	Bore measurement (MH+M)	82
13	ST1 MODE	84
13.1	Generality	84

13.2	Capturing the reference value.....	85
13.3	Reference value management.....	86
13.4	Secondary functions FX.....	86
13.5	Context-based actions	86
14	ST2 MODE	87
14.1	Generality.....	87
14.2	Probe calibration	87
14.3	Capturing the reference value.....	87
14.4	Single & double probing.....	88
14.5	Secondary results	90
14.6	Secondary functions FX.....	91
14.7	Indirect reference (PRESET)	91
14.8	A&B references management.....	92
14.9	Delete last measurement block.....	92
14.10	Edit a measurement block	92
14.11	To run a probe calibration	93
14.12	Distance between two heights	93
14.13	Average between two heights.....	93
14.14	Selection of a measurement block.....	94
14.15	Two measurement blocks selection.....	94
15	MAX, MIN, Δ MODE.....	95
15.1	Introduction	95
15.2	Fine adjustment.....	95
15.3	Measurement principle (MH+M)	95
15.4	Measurement principle (MH).....	97
15.5	Graph	98
16	ANGLE MEASUREMENT	100
16.1	Introduction	100
16.2	Measurement principle (MH+M)	100
16.3	Measurement principle (MH).....	102
16.4	Cone angle measurement principle	103
17	CALCULATOR.....	104
17.1	Generality.....	104
17.2	Concept.....	104
17.3	Use of the measurement blocks	105
17.4	Changing measurements list	105
17.5	Customised calculation function	105
18	PERPENDICULARITY & STRAIGHTNESS MEASUREMENT.....	107
18.1	Generality.....	107
18.2	Mounting an IG13	108
18.3	Mounting a TESA USB probe	109
18.4	Adaptor for IG13 connection	110
18.5	IG13 positioning	111
18.6	Measurement principle.....	111
18.7	Displacement speed and direction (MH).....	113
18.8	Zero setting	114
18.9	Measuring range	114
18.10	To pause the measurement	115
18.11	Measurement results	115
19	2D MODE	117
19.1	Introduction	117
19.2	Concept.....	117

19.3	Two measurement possibilities.....	118
19.4	Application examples.....	119
19.5	Step by step example.....	120
19.6	Results analysis.....	123
19.7	To define a datum.....	124
19.8	Where is the current datum?.....	125
19.9	Change the coordinate system.....	125
19.10	To define an origin.....	126
19.11	To defined a reference axis.....	126
19.12	Midpoint.....	126
19.13	Intersection of two lines.....	126
19.14	Line through 2 points.....	127
19.15	Bestfit line.....	127
19.16	Circle through 3 points.....	127
19.17	Bestfit circle.....	127
19.18	Distance between 2 points.....	128
19.19	Angle by 3 points.....	128
19.20	Angle between two lines.....	128
19.21	Angle with axes of the current datum.....	128
19.22	Perpendicular distance.....	129
19.23	To create a virtual point.....	129
19.24	To create a virtual circle.....	129
19.25	Origin translation.....	130
19.26	Datum rotation.....	131
19.27	How to integrate a result from the 2D mode into a measurement program?.....	132
20	ZZ MODE.....	134
20.1	Generality.....	134
20.2	Operating principle.....	134
21	DATA MANAGEMENT.....	136
21.1	Generality.....	136
21.2	Automatic or manual transmission.....	136
21.3	Transmission format.....	137
21.4	Transmission via TLC (cable).....	138
21.5	Transmission via TLC (wireless).....	139
21.6	Use of the printer.....	139
21.7	*.Pdf report.....	140
21.8	Annotate a measurement program.....	141
21.9	Screenshot.....	142
22	PROGRAM MANAGEMENT.....	143
22.1	Introduction.....	143
22.2	Program creation.....	143
22.3	Insert tolerances.....	143
22.4	Tolerancing with ISO table.....	145
22.5	To save a sequence.....	145
22.6	Sequence loading.....	146
22.7	To run a sequence.....	147
22.8	Pause a sequence run.....	148
22.9	Remeasure a block.....	149
22.10	Waiting time (timer).....	149
22.11	Results.....	150
22.12	To run a sequence in loop.....	151
22.13	Calibration block and execution in a loop.....	151
22.14	Reference block and execution in a loop.....	151

23 CONTROL AND UPDATES	153
23.1 Generality.....	153
23.2 System information	153
23.3 Control of the system	153
23.4 Sensor control	154
23.5 Reference mark control.....	154
23.6 Software update	154
24 CONTEXT-BASED ACTIONS	157
24.1 General actions.....	157
24.2 Actions regarding ST1 & ST2 modes	158
24.3 Actions regarding Perpendicularity mode	158
24.4 Actions regarding Angle mode.....	158
24.5 Actions regarding Min, max, Δ mode	159
24.6 Actions regarding 2D mode	159
24.7 Actions regarding Calculator mode.....	159
OPTIONAL ACCESSORIES:	160
EXAMPLE, TESA WORKPIECE	163

1 INTRODUCTION

1.1 Acknowledgements

Dear user,

We would like to thank you for having chosen TESA as your metrology partner. We thank you for your confidence in purchasing one of our high-end height gauges of our MICRO-HITE or MICRO-HITE+M range.

Your metrological concerns are important to us and we are convinced that this instrument will meet your expectations. We are constantly striving to develop solutions adjusted to your needs.

The result? Your satisfaction for many years. Our pleasure? To know that our products help you meet your needs in research, development and production in a quick and efficient way, and for a long time.

The whole TESA team welcomes you to our family of TESA product users.

Your TESA team

1.2 Warning

This instruction manual must be read by every technician or operator before the installation, maintenance or use of the instrument. Not adhering to certain instructions regarding its use could lead to malfunction or deterioration of the instrument.

1.3 Copyright (document)

The content of this document has been created subject to subsequent modifications without prior notice. All modification rights are reserved.

The French version is the reference language. All other language versions are only translations.

1.4 Copyright (software)

The software delivered with MICRO-HITE or MICRO-HITE+M contains copyright-protected software that is licensed under the following open source licenses:

- MIT: <https://opensource.org/licenses/MIT>
- CDDL: <https://opensource.org/licenses/cddl1.php>
- CPOL: <http://www.codeproject.com/info/cpol10.aspx>
- LGPLv2: <https://opensource.org/licenses/LGPL-2.1>

For more information, please contact your local representative.

1.5 Preamble

The MICRO-HITE or MICRO-HITE+M is the result of more than 70 years of experience in the conception and production of high-precision measurement equipment. It has been designed to meet the needs of a production environment and to offer its users an affordable, quick and precise way for dimensional control of small or large workpieces in workshops or laboratories.



This document describes the different procedures to be followed in order to allow for a quick and easy handling of both our manual range MICRO-HITE 2016 and our motorised range MICRO-HITE+M 2016.



Apart from particular features for each type of displacement and measurement process, the software provided with all height gauges is the same, which allows an experienced user of manual height gauges to easily use an automatic height gauge (and vice versa).

1.6 Symbols

Several different types of symbols are used in this manual. They give important information that has to be taken into account in order to correctly use the measuring instrument.

Position	Description
	Not adhering to these instructions can lead to incorrect measurement results.
	Corresponds to an assistance for better use.

2 PRESENTATION

2.1 General description

The MICRO-HITE 2016 height gauge range is different from any other height gauge as it offers an exceptional performance as well as intuitive and easy use.

This autonomous measuring instrument is designed for measuring lengths such as external, internal, step, height or depth dimensions as well as distances. Its concept also enables measurements of form and orientation tolerances such as straightness or perpendicularity errors.

A cast-iron base (No. 10) including a hardened stainless steel plate supports the instrument. Three resting points guarantee the stability of the height gauge (see [here](#)). The integrated electric pump (No. 12) generates the air cushion so that your height gauge can easily be moved across the granite table.

The rigid vertical column under the protective housing (No. 17) includes the guiding part that is rigorously straight and perpendicular to the base.

A measuring head slides on the guiding element, while the optoelectronic measuring system (patented by TESA) measures any head displacement.

Each height gauge is used with a control panel (No. 14) with numerous calculation possibilities offering a measuring solution adjusted to each application.

Therefore, each instrument features several patented technologies, which makes it a reliable and unique tool that can be used by any operator.

No.	Description
1	Cap cover
2	Electronic system reading the position (sensor + scale)
3	Fixing knob of the measuring carriage
4	Handle for motorised displacement
5	Connector for accessory
6	Information LED
7	Probe support
8	Probe
9	Guiding and support faces
10	Cast-iron base
11	Rotary control handle or handwheel for displacement
12	Electric pump
13	Switch for electric pump
14	Control panel
15	Touchscreen
16	Adjustable arm for control panel
17	Protective housing



The table above shows a motorised height gauge. Apart from No. 4 and 11, all elements of the manual height gauges are identical. The MICRO-HITE doesn't have a handle for motorised displacement (No. 4). Instead it has a handwheel as well as a locking ring as described [here](#) and [here](#).



Fig. Description of the constitutive elements of the TESA MICRO-HITE+M

2.2 Instrument base

The base is chemically nickel-plated in order to make it very resistant to corrosion. Its lower face, which has been machined to ensure that is rigorously flat, includes three finely-machined support lugs (air bearings) that guarantee the stability of the height gauge.

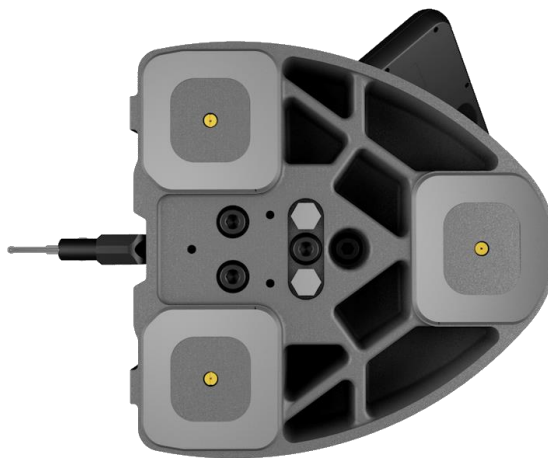

These lugs form a large surface so that any grooves or other similar irregularities on the granite table can be easily cleared.

The faces (9) defined by the red zones in the schema below are specially designed to support the instrument against a parallel gauge block or for guiding it along such a block.



2.3 Air cushion

The air cushion, which is generated by an integrated electric pump, allows the height gauge to be easily moved on the granite table. The height gauge can then be moved effortlessly and any wear created by friction is avoided.



This pump is activated by pushing a control button, which immediately activates an air cushion between the instrument and the granite table (violet zone below), which is only a few microns thick.



The thickness of the air cushion can be adjusted according to the quality of the granite table. You can adjust it via the control software (for further details, see this [chapter](#)).

When measuring workpieces where the dimensions or weight don't allow for any movement, the height gauge can be moved by using the air cushion.



Experience has shown that the air cushion should not be thicker than necessary. When it is activated, it has to support the weight of the instrument while still being slightly in contact with the granite table.

2.4 Vertical column

The rigid vertical column of the instrument is perpendicular to the cast-iron base, to which it is permanently fixed.

The perpendicularity of each instrument is adjusted mechanically in the factory using a patented TESA system, which makes it possible to use it for a reliable and quick control of perpendicularity.



The height gauge is adjusted for frontal as well as lateral perpendicularity measurements.







2.5 Rotary control handle

On the MICRO-HITE+M models, a rotary control handle (FEEL&MOOVE patented system) is located close to the instrument base. It serves for guiding the instrument when it is moved on the air cushion and for starting the fast displacement of the probe as well as for triggering all main measuring functions (up or down probing, bore or shaft measurement).

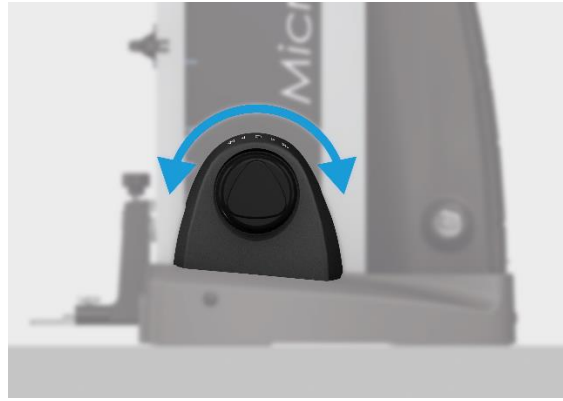





The height gauge is very user-friendly with easy and precise handling. Any fast displacement, slow approach to the point to be measured, probing up and down or bore measurement can be carried out using this rotary control handle.

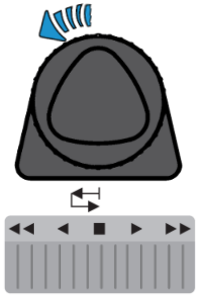

In general, the following measuring functions can be executed directly via this rotary control handle, without the need to select the key on the keyboard of the control panel: ,  and .

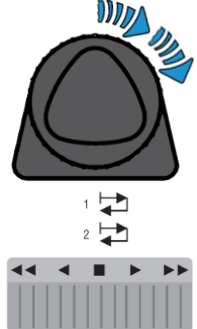
Definition of actions		
		<p>Moving up Turning the rotary control handle clockwise will move the probe up.</p>
		<p>Moving down Turning the rotary control handle counterclockwise will move the probe down.</p>
		<p>Probe positioning A continuous rotation of the rotary control handle accelerates the displacement of the probe progressively (speed of displacement according to the rotation angle). It will decelerate and then stop when approaching the zero point ■ or when releasing the rotary control handle.</p> <p>The rotation window between ◀ and ▶ is considered as the speed window that corresponds to the position of the probe.</p>
		<p>Fast displacement In case of a large distance between two points to be measured, you can move the probe in such way that the displacement time between two measurements is minimised. To do so, the rotary control handle features another graduation (from ◀ or ▶ to the end), which allows a fast displacement of the probe.</p>
		<p>Probing up One small and fast rotation (no need of a long rotation) of the rotary control handle to the right side will start probing up. The column will move up until the probe is in contact with the workpiece.</p>

		<p>Probing down Same as for probing up.</p>
		<p>Bore measurement Activating the rotary control handle twice in the same direction allows bore measurement with detection of the culmination point.</p> <ul style="list-style-type: none"> •When rotating clockwise, the measurement will start with probing the upper point of the bore. •When rotating counterclockwise, the measurement will start with probing the lower point of the bore.

 **When an automatic measurement process is started (not necessarily with the rotary control handle), it is possible to stop it by a short rotation/activation of the rotary control handle in the opposite direction of the one of the movement or by pressing one of the keys of the control panel keyboard.**

2.6 Handwheel

On manual models, the main handwheel located above the base is the element that allows you to move the probe during a measurement.



 **The handwheel can include a fine adjustment system, which allows to adjust the displacement to the measurement of small elements. A manual MICRO-HITE that does not include that system can be upgraded at any time with it.**

For further information, please contact your local reseller.

This handwheel and the drive system it is linked to have been specially designed to allow the user to feel the different pressure on the probe and when the measurement is carried out.

2.7 Lever-type locking ring

The lever-type ring allows to tighten the drive of the measuring head, which can still be slightly moved.



This ring is mainly used for bore and axis measurements (static process) in order to allow the determination of the culmination point. It is also used to avoid any displacement of the carriage when the system is transported.

2.8 Electric power supply

There are two different possibilities for supplying the instrument with power.

- Via a power supply (TESA reference: 00760245)
- Via a rechargeable removable battery (TESA reference: 00760244)

The battery simplifies working on the granite table as no power cable hinders the operator when displacing the height gauge.



The battery also supplies the panel connected to the instrument base with power.



It is important to always use the cable and power supply unit provided with the height gauge (TESA reference mentioned above). Not adhering to these instructions can lead to malfunction of your instrument or irreversibly damage it.

In case of questions, please contact your local reseller.

2.9 Measuring system

The height gauge features an optoelectronic measuring system digitally capturing the measured length, which is also called measurand (TESA patent). The glass scale with both incremental graduations and a reference mark serve as material measure. According to a principle of reflection, the scale is scanned by a sensor with no mechanical contact. The measuring signal is then transmitted to the control panel.

From the neutral position A, the system for determining the measured values can move in both directions up to the switch points. As soon as one of the two points is reached, it starts capturing and the information is sent to the control panel.



In order to guarantee that your height gauge is functioning correctly, it is important that the scale and the sensor remain free of any solid or liquid particles that could impede the functioning of the scale.

The distance C, which is symmetrical to the position of the relevant trigger point, is only used for detecting the culmination point when probing cylindrical circular surfaces (for further details, see this [chapter](#)).

The system for obtaining the measured values can be moved from the neutral position up to the spring-loaded end stops via the distance D. However, too much pressure will lead to an invalid measurement of the point.

On the manual MICRO-HITE, the probing force (and therefore the position of the probe on the measuring carriage) is visible through a coloured bar on the right side of the screen. At any moment, when the probe comes in contact with the workpiece to be measured, this bar is activated and changes its colour according to the applied pressure.

When the probe touches the piece, the bar on the right displays a unique horizontal black mark.

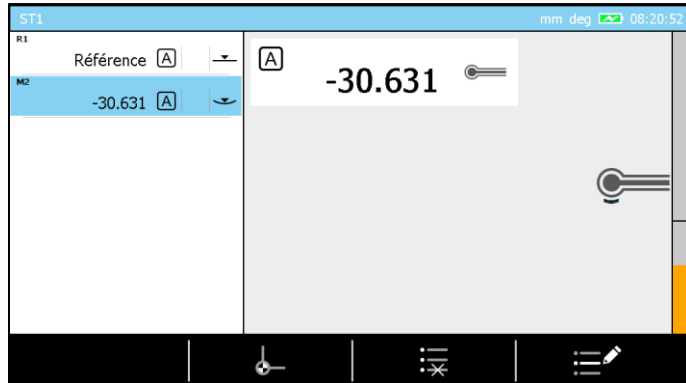

This mark corresponds to the minimum required pressure in order to have a single probing be taken. If the pressure is not high enough, the bar colour is orange. When the mark has been passed by the displayed force, the colour becomes green or even red if the pressure is too high.

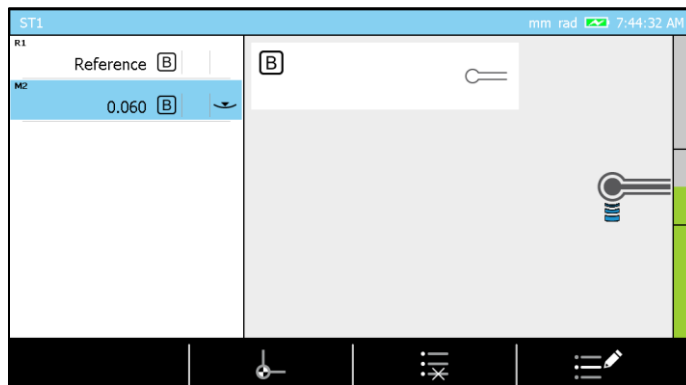

Two horizontal lines are also displayed in the middle of the bar. They represent the ends of the measurement zone defined by letter C in the table below.

Position	Description
A	Neutral position
B	Travel to the upper (resp. lower) trigger point for determination of the value
C	Partial measuring span for detecting the culmination point
D	Travel in one direction from the neutral position to the end stops.

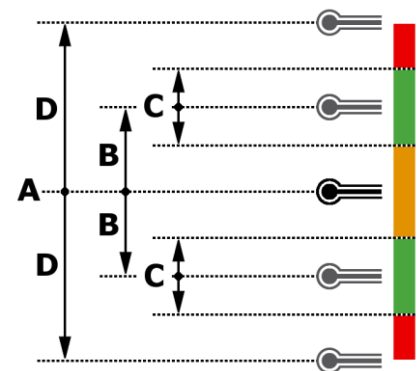

2.10 Control panel

The control panel has been developed as ergonomic and intuitive as possible. Its keyboard is separated in 4 different zones each focusing on particular actions.



For further details, see this [chapter](#).

2.11 Fixing arm

As all environments the instrument is used in are different, your system includes a flexible control panel support, which offers you two degrees of freedom through adjustable screws. Then it is possible to:

- adapt the angle of the screen for easier reading
- position the control panel for an ideal ergonomic use



2.12 Information LED

For more comfort during measurements, an informative LED has been placed at the end of the probe support mounting shaft. This LED changes its colour according to the current action and the measurement pertinence.



This system developed by TESA is patented.

For further details, see this [chapter](#).

2.13 Interface & displayed values

The ergonomic software has been designed to avoid any ambiguous situations. At any time, the displayed values correspond only to a measurement or a calculation and never to the probe position (except in mode “scanning” or *Max, Min, Δ* ).

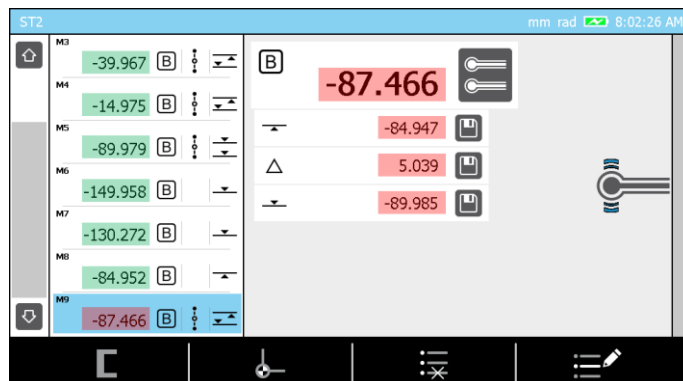

Results of last measurement in red, previous measurement results in green.



In order to avoid any reading errors of the displayed values on the screen, only measurement results or calculations are visible. Except for a few specific modes, your height gauge will not display the current value of the position of the probe.

2.14 Printer

An USB matrix printer especially designed for your height gauge is available as an optional accessory.

Its installation does not require any special intervention. Each MICRO-HITE or MICRO-HITE+M is directly compatible with this printer, which can be connected to an USB port on the back of the control panel at any time.



For further details on the printer installation, see this [chapter](#). For its use, see this [chapter](#).

2.15 Connectors

The control panel features several connectors allowing to manage the obtained data. Besides three USB connectors on the top of the back, there is also a TLC (TESA Link Connector) IP65 connector, which enables you to send data to an external device.



No.	Description
1	TLC connector (equivalent to standard serial output)
2	Power supply (not used when the control panel is connected to the height gauge via connector No. 4)
3	USB connectors
4	“Height gauge to control panel” connector

For further details, see this [chapter](#).

3 TECHNICAL SPECIFICATIONS

Series	MICRO-HITE			MICRO-HITE+M		
Reference	00730073 00730076	00730074 00730077	00730075 00730078	00730079	00730080	00730081
Displacement	manual	manual	manual	motorised	motorised	motorised
Model	350	600	900	350	600	900
Application range [mm]	520	770	1075	520	770	1075
Dimensions [mm]						
• Height	782	1032	1332	782	1032	1332
• Width	380	380	380	380	380	380
• Depth	280	280	280	280	280	280
Weight [kg]	33	37	45	33	37	45
Max. permissible error [µm] L in mm	2+2L/1000	2+2L/1000	2+2L/1000	1.8+2L/1000	1.8+2L/1000	1.8+2L/1000
Repeatability [µm]						
• On surface (2σ)	1	1	1	0.5	0.5	0.5
• On arc (2σ)	1	1	1	1	1	1
Perpendicularity* [µm]						
• Frontal	5	7	9	5	7	9
• Lateral	5	7	9	5	7	9
Battery life [h]	8	8	8	8	8	8
Probing force [N]	1.6 ± 0.25	1.6 ± 0.25	1.6 ± 0.25	1.6 ± 0.25	1.6 ± 0.25	1.6 ± 0.25
Resolution [mm]	0.0001	0.0001	0.0001	0.0001	0.0001	0.0001
Air cushion	●	●	●	●	●	●

*using the IG13 accessory.

4 DELIVERY CONTENTS

4.1 System components

Each configuration is composed of the following elements:

Qty	Description	TESA reference
1x	Height gauge	-
1x	Control panel	00760233 (MICRO-HITE) or 00760234 (MICRO-HITE+M)
1x	Articulated arm	061784
1x	Standard probe support	00760243
1x	Hardprobe, Ø 5 mm	00760227
1x	Master piece	00760236
1x	Rechargeable battery	00760244
1x	Power supply	00760245
1x	SCS calibration certificate	-
1x	Declaration of conformity	-
1x	Quick start manual	-
1x	USB key	-
1x	Shipment case	-

4.2 Packaging

The elements that constitute the packaging of your height gauge are very important, therefore you should keep them. It is absolutely necessary to use the original packaging when transporting the instrument in order to avoid any unfortunate deterioration which could cause malfunction or complete impossibility to use the instrument.

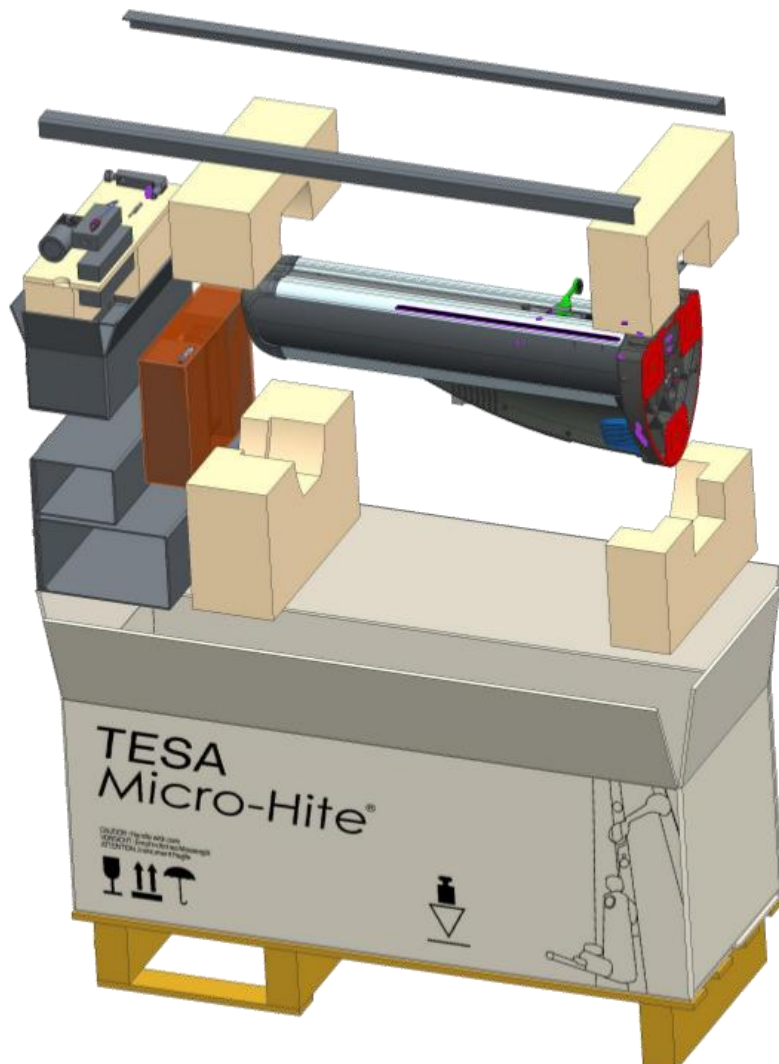

4.3 Fine adjustment system

Certain height gauge models also include a fine adjustment system for precise and sensitive displacement of the probe:

- 00730076 MICRO-HITE 350F
- 00730077 MICRO-HITE 600F
- 00730078 MICRO-HITE 900F

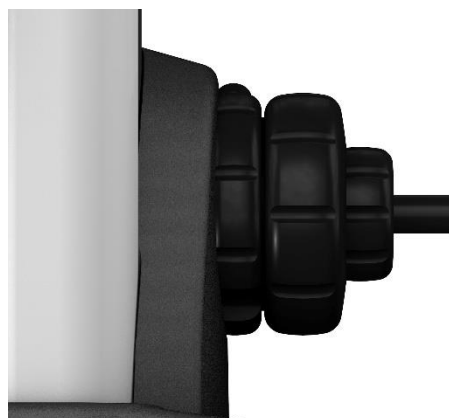

A manual MICRO-HITE that does not include this system can be upgraded at any time.

For further information, please contact your local reseller.

4.4 Calibration certificate

Each MICRO-HITE and MICRO-HITE+M is provided with an individual calibration certificate. The number of the certificate is the same as the serial number of the instrument, as it is indicated on its label. If the two numbers are not the same, please contact your local reseller.

The documented measuring results of the calibration certificate refer to the condition of the instrument during its final inspection in the factory of TESA. The results obtained and the technical specifications indicated depend on the environmental factors. If the instrument is not used in ideal conditions, it is very likely that its performances will be downgraded.

Reference conditions during calibration

Air conditioning in measurement laboratory	Temperature: $(20 \pm 0,5) \text{ }^\circ\text{C}$ Humidity: $\leq 65 \%$
Flatness standard	Granite table, precision class 00 according to DIN 876 part 1 Total guaranteed flatness of $1 \text{ } \mu\text{m}$.
Control equipment for determining measurement uncertainty of lengths	Step gauge block with nominal distance of the measuring faces of 20 mm. The measurement line of the step gauge block is oriented perpendicularly to the reference granite plate
Instrument	Equipped with standard probe with hardprobe, $\text{Ø}5\text{mm}$ (TESA reference 00760227) and a standard probe support (TESA reference 00760243)
Master piece	Belonging to the instrument itself, therefore same number on it as indicated on gauge label.

Measurements

- The measuring face of the step gauge block, which is approximately at the same height as the reference surface of the granite plate, is the reference point for measurements.
- The reference point is captured once (probing down) and is valid for the following three series of measurements.
- For each series, the measurements of the step gauge blocks are carried out with regular nominal distances of 20 mm (see calibration certificate).
- The measurements are carried out with inversion of the probing direction. This means that the measuring faces of the step gauge blocks are probed alternately up and down until the end of the measuring range of the instrument is reached.

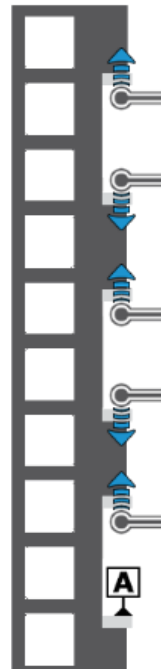

Schema representing an example of step gauge blocks on which BMPE measurements are carried out

Interpreting the results

Interpreting the results according to the standard ISO 13225 your height gauge refers to, requires a definition of the following parameters.

- B** Error of indication of the height gauge for surfaces measured in opposite directions. We talk about bi-directional measurements.
- B_{MPE}** Upper tolerance of B parameter.
- E** Error of indication of the height gauge for surfaces measured down. We talk about uni-directional measurement.
- E_{MPE}** Upper tolerance of E parameter.
- R** Repeatability error (2σ).
- R_{MPE}** Upper tolerance of R parameter.

For informative purposes, parameters that correspond to perpendicularity are given by:

- S** Perpendicularity error (ZX).
- S_{MPE}** Upper tolerance of parameter S.

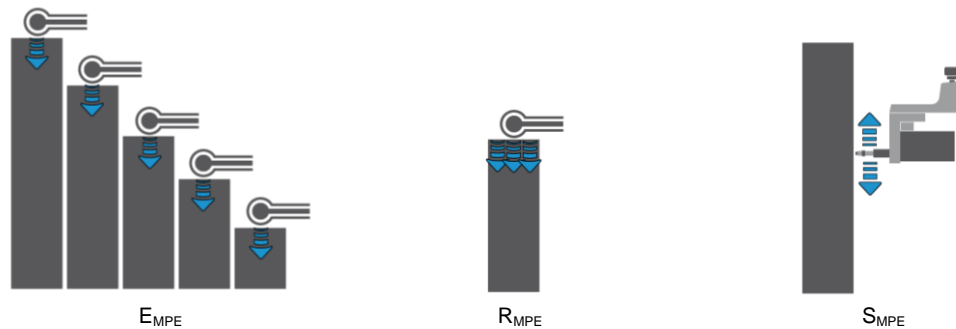

The maximum permissible error is indicated as follows (A, B, C and D are constants, L corresponds to the measured length in meters).

$$B_{MPE} = A + B \times L$$

$$E_{MPE} = C + D \times L$$

Starting from the zero reference point, with its height position corresponding approximately to the reference surface of the granite plate, no error (measured value – nominal value) is above the admissible limits. All measuring results are therefore in the violet zone.

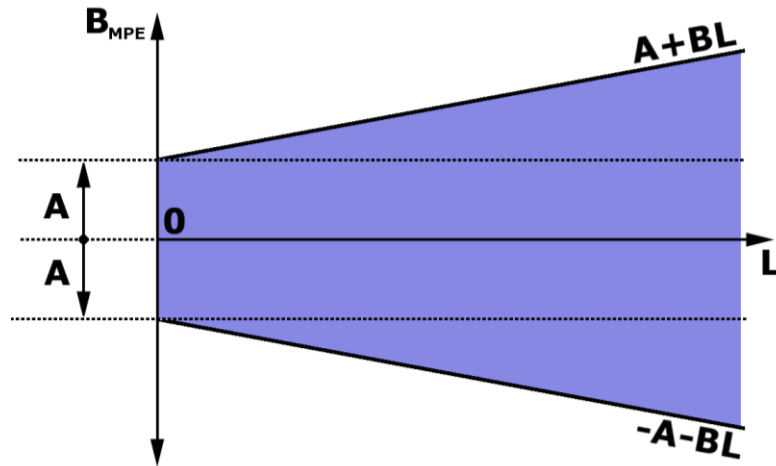

The visualisation of the schema of E_{MPE} is identical to the one above, except that parameters A and B are replaced by C and D . It is also possible that the technical specifications of certain products indicate $A = C$ and $B = D$.



The MICRO-HITE and MICRO-HITE+M are instruments with a “fixed zero”. This means that in order to have measuring results in accordance with the specifications indicated by the maximum permissible error, the reference used in a measurement sequence has to be measured on the granite table generally used for most applications.

5 INSTALLATION, SECURITY & MAINTENANCE

5.1 Location	The instrument has to be installed in a location satisfying the general required conditions, but also the specific and very precise conditions regarding the environment, power supply, etc. It is essential to be able to identify important factors and to correctly prepare the zone the instrument is installed and used in.
5.2 Place of use	In order to use the instrument correctly, the following precautions have to be taken into account: <ul style="list-style-type: none">• Avoid placing the instrument close to a window, door, cooling or heating system.• Avoid causing recurrent temperature variations due to direct exposure of the instrument to the sun.• Avoid installing it close to other machines that could induce large electromagnetic fields.
5.3 Lighting	Use indirect or fluorescent light. Avoid direct exposure to the sun or any other strong light.
5.4 Measuring surface	Choose a surface free of any vibrations that could lead to measurement or reading errors despite the stability of the mechanical and electronic components. Make sure that the surface can carry the weight of the machine and the workpiece to be measured. Ideally, the surface should not have any splits or joints. It is recommended to use a measuring surface that is big enough to enable smooth and easy movements of the instrument around the workpiece to be measured if the latter cannot be displaced manually.
5.5 Cleanliness	Make sure that the floor surface is clean, so that there is no dust, condensation or metal filings. The supports and scales have to be perfectly clean without any oily particles on it.
5.6 Vibrations	Floors of companies are constantly at risk of vibration due to different reasons: CNC and other machines, transportation vehicles and any other source of vibrations. These vibrations can directly influence the metrological performances of the machine.
5.7 Electric power supply	Stability When the instrument is powered electrically via the cable connected to the network, make sure that the electric power supply of the machine is as stable as possible, as it could otherwise deteriorate the system. If the electric network the machine is connected to does not provide sufficient stability, it is highly recommended to use an additional device to avoid any damage. These devices can be found locally. Power cable Do not use any other power cable than the one provided with the instrument. Transformer Do not use any other transformer than the one provided with the instrument. Voltage Do not use the instrument with any other voltage than the one indicated in this manual.

5.8 Batteries

Interchangeability

MICRO-HITE height gauges are provided with batteries easily accessible and removable from the instrument.



When using the instrument essentially with battery power supply, it is highly recommended to purchase a second battery (TESA reference: 00760244) that enables you to always have one operational battery while the other one is charging, thanks to the interchangeable system.

Recharging the batteries

The batteries are only to be recharged with the charger provided with the height gauge (TESA reference: 00760251).



Not adhering to this rule can cause irreversible damage to the instrument or its instability.

A battery security sheet is delivered with the height gauge (available from USB stick) or can be obtained through your local TESA representative. Refer to this document if the battery is damaged.

In case of damaged or if you suspect a malfunction do not send it back and contact your TESA local representative.

When a battery is connected to the height gauge which is powered by its charger, the battery also recharges. In case you are using two (or more) batteries, the battery which is not in use can be recharged with a recharging station (TESA reference: 00760245).



During this use, the height gauge power supply is not connected to the column itself but directly to the recharging station.

5.9 Final use	The instrument is to be used for measurements only.
5.10 Storage	It is important to respect the storage temperature limit indicated in the specifications of the instrument.
5.11 Cleaning	Only use a dry, lint-free cloth for cleaning the instrument. Do not use aggressive solvents.
5.12 Opening elements	Never try to open the control panel or the height gauge. Access is only allowed to qualified and authorised personnel. <div data-bbox="399 1120 1497 1220"> If a person not authorised opens one of these elements, the warranty period automatically ends.</div>

6 INSTALLATION

6.1 Packaging

Each MICRO-HITE or MICRO-HITE+M instrument is delivered in packaging developed to protect it from shocks and corrosion.



Only transport the height gauge in this packaging. Any other transport using unofficial packaging is not recommended and will not be covered by TESA in case of dispute.

6.2 Unpacking & installation

1. Bring the pallet as close as possible from the installation area



2. Remove from pallet, accessories and panel boxes as well as documents cardboard folder.



3. Remove power supply and cables from the box.



4. Remove the masterpiece from the box and its plastic bag. Clean its base before placing it on the granite table.



5. Remove the probe and its support from the box. Mount the probe on the support. Do not forget to tighten the assembly with the tightening wheel.



6. Accessories are now ready to be used.



7. Remove the top two protection foam pieces from pallet



8. With a second person, remove carefully the gauge from the pallet



It is highly recommended not to do this step alone. Two persons are required to avoid any damage of the instrument in case of a shock or an incautious movement. Because of the weight of the instrument, it is not recommended to lift the unit on your own.



9. Carefully place the height gauge on the measuring surface keeping it in a horizontal position.



The MICRO-HITE+M are equipped with a handle directly fixed on the carriage system.



This handle is used for manual fast displacement of the probe between two measurement zones. It is very fragile and no force whatsoever must be applied on it, except for the force applied for normal displacement during a measurement.

It cannot be used as a handle when moving the instrument as it could be heavily damaged or completely broken.

10. Delicately unpack the plastic cover protecting the base of the height gauge



11. Make sure you have access to the displacement lugs.



12. Remove the grease from the instrument base surface. Use a non-aggressive solvent to do so.



13. Install the instrument vertically on the clean granite plate (or any other support).

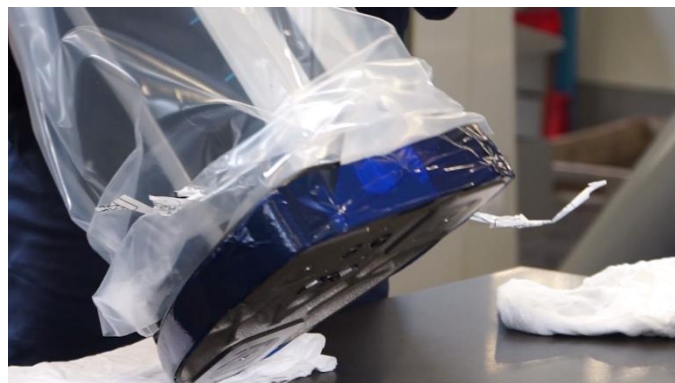

14. Remove the protective plastic cover



15. Remove carefully the panel arm protection



16. Remove carefully the protective tape from the base, the handle and the gauge top's cap.



17. Remove the two screws from the front shipping bracket



18. Pull carefully the plate

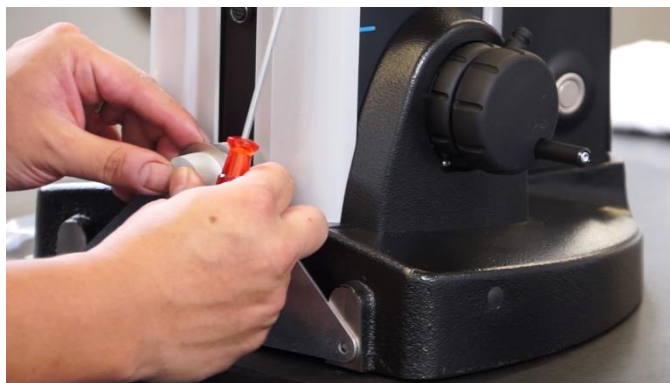

19. Remove carefully the shaft protection (where the probe holder is going to be mounted).



20. Mount the probe support and its probe on the shaft.



21. Screw the reference half-spheres to the base of the instrument



22. Unscrew the double carriage locking screw (positioned above the probe support)

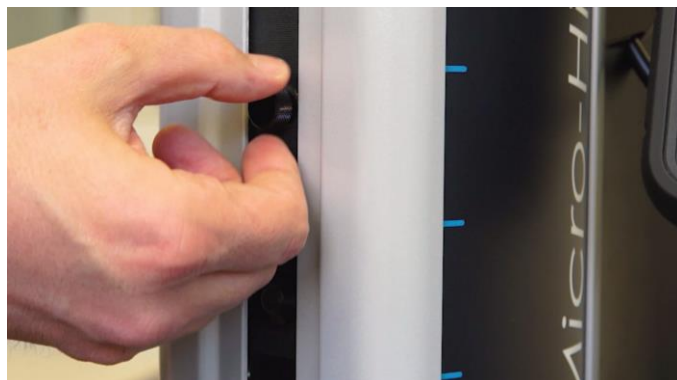

23. Remove the panel from its box



24. Screw the control panel on the articulated support.



Any cable connections have to be established while the instrument is turned off. Make sure that the instrument is turned off each time the control panel/height gauge cable is connected or disconnected.

25. Connect the control panel to the height gauge



26. Make sure that the battery is well fixed in the height gauge.

27. Connect the height gauge to a source of power using the power supply unit for direct mains operation or subsequent use (with batteries once they are charged).



6.3 Installation of the printer

1. If necessary, remove the MICRO-HITE or MICRO-HITE+M control panel by unscrewing the 4 screws.



2. Hold the printer in position and screw the same 4 screws.



3. As soon as the printer is correctly fixed, it is necessary to connect it to the panel via the USB cable provided with it.



4. Connect the power jack as well.



Your printer is now ready to be used by activating the process in the system settings. For further information, see this [chapter](#) or the printer user manual.

6.4 Installation of the foot switch

You can use your height gauge together with two different types of switches: operable with the hand or the foot.



Foot switch
04768001



Hand switch
04768000

These two switches have a jack plug. To use them you must connect them to the back of your height gauge, above the power connector.

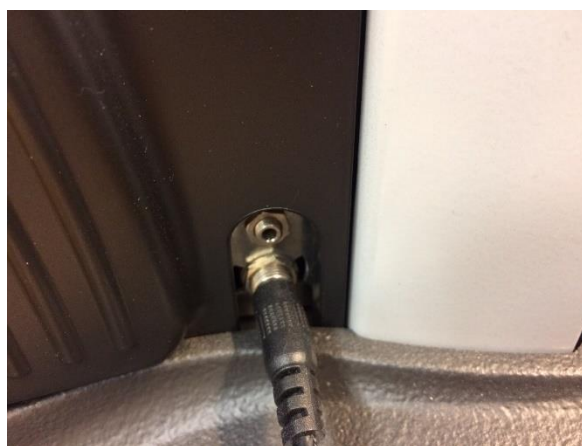

7 CONTROL PANEL

7.1 General description

The control panel of your height gauge has been developed to enable an ideal navigation through its software and an intuitive use.

Its keyboard is separated in four zones of keys that are easily distinguishable by the functions accessible through them.

The panel below is defined for the motorized MICRO-HITE+M height gauges. The panel provided with the manual models has fewer features in zone No. 1.



No.	Description
1	Measurement zone + numerical keyboard <ul style="list-style-type: none"> Start a measurement (on MH+M) Define the type of measurement: axis or bore (on MH) Insert a numerical value
2	Calculation zone <ul style="list-style-type: none"> Calculate differences or averages Manage references Change measuring units Manage transmission of data Access to secondary functions
3	Software navigation <ul style="list-style-type: none"> Turn the instrument on or off Access to online help Validate or cancel actions Go back to main menu Displace selection of options
4	Validation of context-based options

7.2 Touchscreen

To offer you more comfort, most of the functions available via the keyboard of the control panel are also available via the touchscreen.

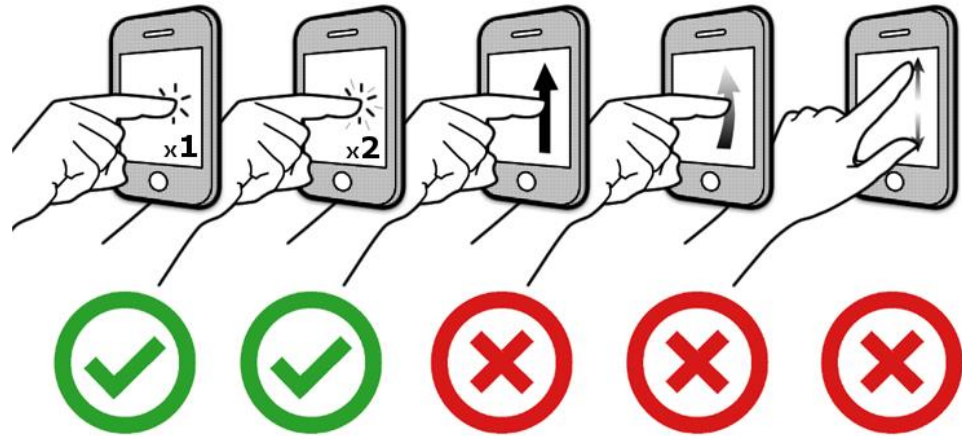

The control panel is touchscreen only technology. Swiping the screen is not possible.









7.3 Measurement zone

There are two different types of actions possible using the keys of this zone:

- Numerical keyboard
- Measurement function

The numerical keyboard can be used at any moment, when the user has to enter a value manually. The user has the possibility to enter it via the control panel keyboard or on the touchscreen.







Definition of keys	
	<ul style="list-style-type: none"> Start automatic bore measurement (MH+M) Define bore measurement process (MH) Insert value 1
	<ul style="list-style-type: none"> Start automatic measurement of maximum internal culmination point (MH+M) Insert value 2
	<ul style="list-style-type: none"> Start automatic measurement of minimum internal culmination point (MH+M) Insert value 3
	<ul style="list-style-type: none"> Start automatic axis measurement (MH+M) Define axis measurement process (MH) Insert value 4
	<ul style="list-style-type: none"> Start automatic measurement of minimum external culmination point (MH+M) Insert value 5
	<ul style="list-style-type: none"> Start automatic measurement of maximum external culmination point (MH+M) Insert value 6
	<ul style="list-style-type: none"> Start automatic groove measurement (MH+M) Insert value 7
	<ul style="list-style-type: none"> Start automatic measurement of upper point (MH+M) Insert value 8

		<ul style="list-style-type: none"> Start automatic measurement of lower point (MH+M) Insert value 9
		<ul style="list-style-type: none"> Start automatic measurement of a rib (MH+M) Insert a point or comma
		Insert value 0
		<ul style="list-style-type: none"> Save the position of the measuring probe in the memory Change the sign of the active value

7.4 Calculation zone



This zone features different functions:







- Calculation function
- Managing references
- Access to secondary menus
- Transmission of data
- Change of unit

Definition of keys	
	<ul style="list-style-type: none"> • Calculation of the difference between two selected values • Calculation of the distance between two points and creation of a result block (2D mode) • Calculation of the difference between the two last measurements (if two blocks are not selected) • Creation of a measurement block
	<ul style="list-style-type: none"> • Calculation of the midpoint between two selected values • Calculation of the midpoint between the two last measurements (if two blocks are not selected) • Creation of a measurement block • Creation of a block corresponding to the midpoint between two selected points (2D mode)
	<ul style="list-style-type: none"> • Definition of reference A • Recall reference A
	<ul style="list-style-type: none"> • Definition of reference B • Recall reference B
	Access to secondary functions
	Change of unit
	<ul style="list-style-type: none"> • Manually send measurement values to the activated devices • Screenshot saved in USB key

7.5 Software navigation

The keys in this zone allow the user to move the selected zone to the requested place and to navigate through the software.

Definition of keys	
	Activate the help menu for the active page
	<ul style="list-style-type: none"> • Turning on and off the instrument. • When the instrument is in standby mode, the backlight of this button turns blue. It is the only backlit button on the entire keyboard.
	Return to main menu

	
	Move the selection to the left
	Move the selection up
	Move the selection to the right
	Move the selection down
	Cancel
	Validate

7.6 Context-based actions

At any moment of the software use, context-based actions will be displayed in the black bar positioned at the bottom of the screen.

These options can be selected either directly touching the screen or pressing the key  that corresponds to the respective action.

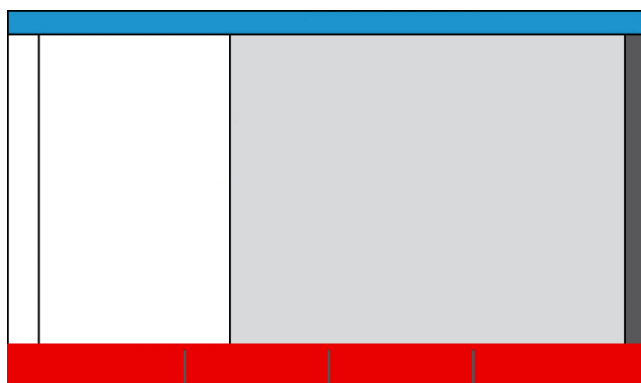

Location of additional options displayed according to the active page

A chapter which summarises the context-based actions is available at the end of this document.

8 MEASUREMENT INTERFACE

8.1 Status bar

The status bar on top of the screen gives you access to the state of the system at any time.



This bar provides the following information:

Calculator	The title of the active page/mode
	If the height gauge is connected to its power supply. No icon is displayed when the height gauge is powered by the battery.
1:49:35 PM	Time
	The active devices when sending data
mm deg	The active units

8.2 Main zone

All values and measurement results will be calculated and displayed in the main zone corresponding to all red rectangles in the picture below.

Information and help regarding the different steps of a process will also be displayed in this zone in order to help the user with the measurement.

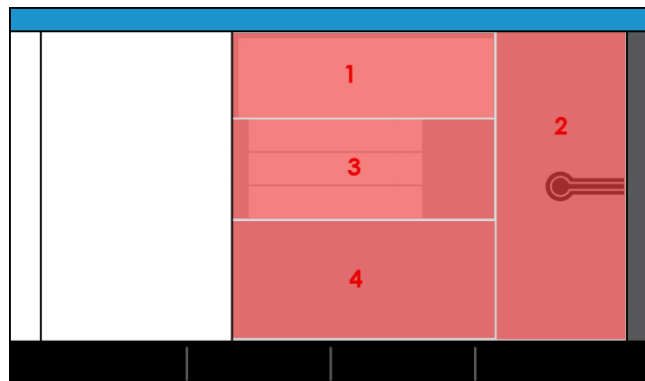



No.	Description
1	<ul style="list-style-type: none"> • Display of the main measurement value. • Information of number of probe hits required to finish a measurement
2	Information/help image regarding the active mode and the step of the measurement process
3	<ul style="list-style-type: none"> • Secondary results • Values used for the active process (example: gauge block's size for angle measurement)
4	Information/help text (linked to the action defined in zone No. 2)

8.3 Measuring force

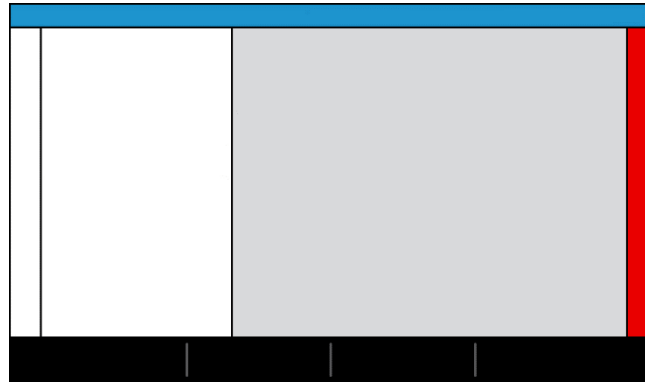
The zone dedicated to the measuring force is displayed on the right of the screen.



When capturing a point, this bar will change its colour according to the force applied on the probe and thus measuring carriage.

Colour	Description
	The pressure applied on the probe is perfect. The measurement is correct.
	The pressure applied on the probe is not sufficient to trigger the measurement.
	The pressure applied on the probe is too high. The measurement would not be correct and is therefore not possible.

8.4 Context-based actions bar

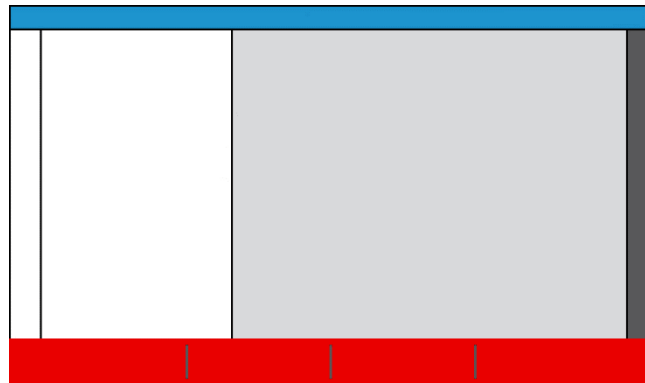

In this bar, additional actions to the possibilities offered by the keyboard of the control panel are displayed. These options are directly linked to the active page of the software.

8.5 Measurements list

After each measurement, the main result is, in general, automatically saved in this zone within a measurement block containing several pieces of information.

 **However, in certain modes, after a measurement, the user has to select from a list of results (zone No. 3 of chapter 8.2) which value is relevant enough to be saved in the measurement memory/history.**

This zone serves as a memory of measurements in order to save them later. This will then allow to restart the measurement sequence on another similar workpiece.



The measurement blocks are defined by:

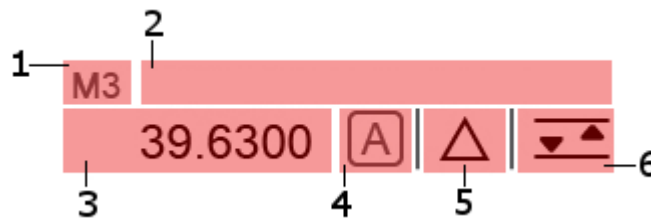

No.	Description
1	Number of the measurement block
2	Editable name of the measurement block
3	Measurement result
4	Reference linked to the measurement result
5	Feature of the measured element
6	Measurement action or measured element

Our example above shows that the third measurement of the sequence has been carried out in datum A on a groove with a dimension of 39.63 mm.





The maximum number of measurement blocks (considering all different measurement lists as ST1, ST2,...) is approximately 2000. Since each block does not have the same amount of information, it is possible that this upper limit varies depending on the measurements stored in the histories.

An alert message is displayed when the maximum limit is reached.

8.6 Location



If the number of displayed blocks in the history exceeds the size of the screen, this tool allows to:

- navigate through the measurement programme via the keys  and .
- to see the instant location in the programme at any moment via a .

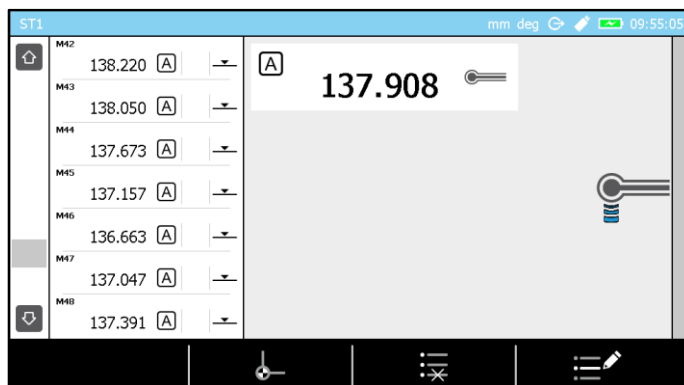

When recalling a measurement sequence, a  will give information about the step of the measurement or the measurement block which the software is in and has to be carried out.

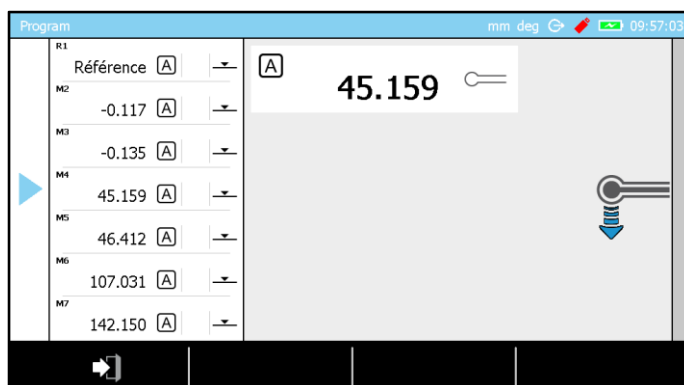

9 SYSTEM OPTIONS

9.1 Access

The system options are accessible at any moment from the main menu by pressing the key .







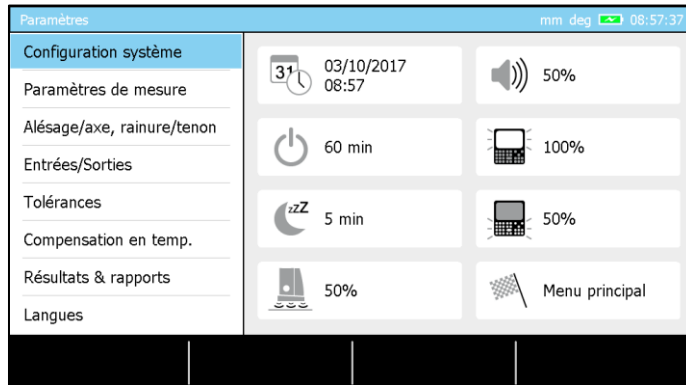



It is possible to go back to main menu from any page of the software by pressing the key .

9.2 System configuration











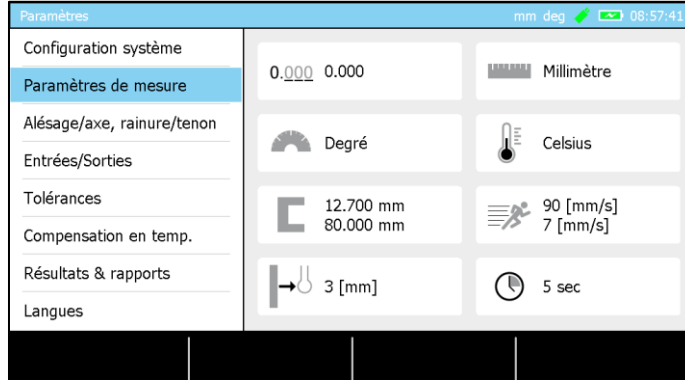

Definition of options

	Definition of time and date
	Time defined before complete shutdown of the system (if the system is not used during this period). If the height gauge is connected to the electric power network, this option is not taken into account and the height gauge will not shut down automatically.
	Time defined before standby mode of the system (if the system is not used during this period).
	Defines the activated mode directly after instrument's initialisation. <ul style="list-style-type: none"> • ST1: direct access to ST1 mode • ST2: direct access to ST2 mode • Main menu: direct access to the main menu
	Managing the loudspeaker
	Managing the screen brightness

	Managing the air cushion
	Managing the keyboard's backlight



9.3 Measurement parameters





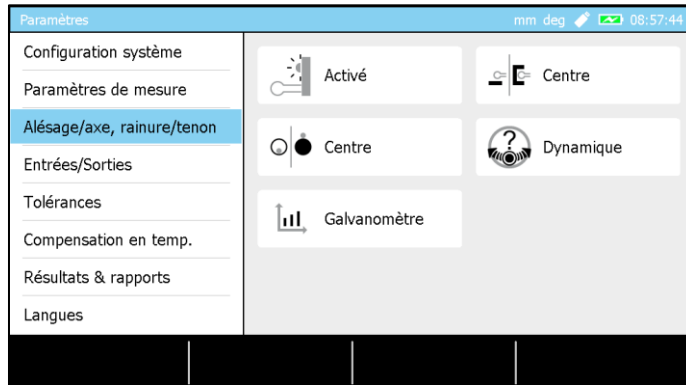

Definition of options	
	Definition of the resolution <ul style="list-style-type: none"> • Metric: 0.00, 0.000, 0.0000 • Imperial: .000, .0000, .00000
	Managing the unit <ul style="list-style-type: none"> • Metric • Imperial
	Definition of the angle unit <ul style="list-style-type: none"> • DD:MM:SS • Degree • Radian
	Managing the temperature unit <ul style="list-style-type: none"> • Celsius • Fahrenheit
	<ul style="list-style-type: none"> • Size of the master piece • Height of the automatic positioning of the probe when starting the probe calibration's process (for MH+M)
	Retract distance after probe hit (for MH+M)
	Speed (for MH+M) <ul style="list-style-type: none"> • Fast displacement speed (for MH+M): 30, 50, 70, 90 mm/s • Probing speed (for MH+M): 7, 14 mm/s <div style="background-color: #f0f0f0; padding: 5px; margin-top: 10px;">  <p>The technical specifications announced for a MICRO-HITE+M were calculated with a probing speed of 7mm/s. Any variation in the probing speed in comparison with the latter may also lead to variations in the precision of the instrument.</p> </div>
	Waiting time when running a program (for MH+M): <ul style="list-style-type: none"> • before moving to another measurement zone • before the measurement <p>If the distance between the current and the next measurement area is close enough, the software will activate the countdown until the next measurement only once.</p>

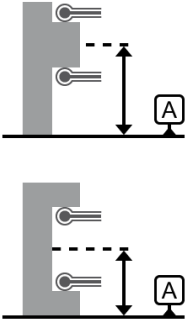
9.4 Bore/axis, groove/rib measurement

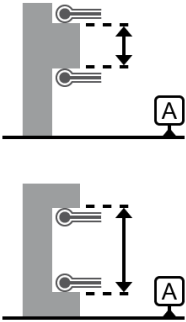

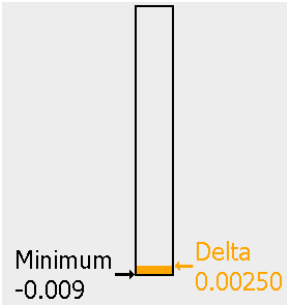
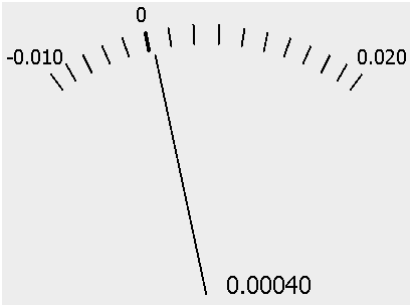
Definition of options	
	<p>Managing the information LED when taking a point:</p> <ul style="list-style-type: none"> • enabled • disabled
	<p>Definition of a culmination point detection process</p> <ul style="list-style-type: none"> • Static <ol style="list-style-type: none"> a. Positioning the probe at the culmination point by moving the workpiece Then the workpiece is no longer moved and: b. Height measurement of one (or two) culmination point(s) without moving the workpiece by simple up/down probings. • Dynamic Culmination point (height) calculated on the fly by moving the workpiece <p>For further details, see this chapter.</p>
	<p>Setting the results main value when measuring a groove / rib.</p> <ul style="list-style-type: none"> • Midpoint of an element The main value is the midpoint of the element (for further details, see this chapter). This value is automatically stored in a new block of the measurement memory. <div style="text-align: center;">  </div> <ul style="list-style-type: none"> • Size/width of an element The main value (for further details, see this chapter) is the size/width of the element (height difference between high and low point). This value is automatically stored in a new block of the measurement memory.

	 <ul style="list-style-type: none"> Midpoint & size/width The main value is the midpoint of the measured element (for further details, see this chapter). However, two independent blocks will be created automatically at the end of the measurement history. These two blocks will store the midpoint value as well as the size/width of the element. Size/width & midpoint The main value is the size/width of the measured element (for further details, see this chapter). However, two independent blocks will be created automatically at the end of the measurement history. These two blocks will store the midpoint value as well as the size/width of the element.
	<p>Selection of the type of graph helping to detect the culmination point. This selection defines the type of chart that will be displayed by default. However, you can also change the type in the measurement mode when the graph is displayed.</p> <ul style="list-style-type: none"> Bar graph Galvanometer <div style="display: flex; justify-content: space-around; align-items: flex-end;"> <div style="text-align: center;">  <p>Bar graph</p> </div> <div style="text-align: center;">  <p>Galvanometer</p> </div> </div>
	<p>Setting the results main value when measuring a bore or axis.</p> <ul style="list-style-type: none"> Midpoint The main value is the height of the centre of the element (for further details, see this chapter).

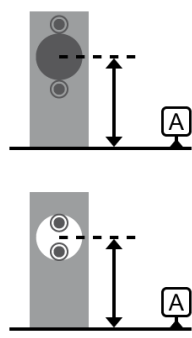

- Diameter**
 The main value is the diameter of the element (for further details, see this [chapter](#)).

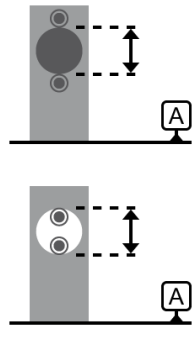

- Midpoint & diameter**
 The main value is the midpoint of the centre of the element (for further details, see this [chapter](#)). However, two independent blocks will be created automatically at the end of the measurement history. These two blocks will store the midpoint value as well as the diameter of the element.
- Diameter & midpoint**
 The main value is the diameter of the element (for further details, see this [chapter](#)). However, two independent blocks will be created automatically at the end of the measurement history. These two blocks will store the midpoint value as well as the diameter of the element.

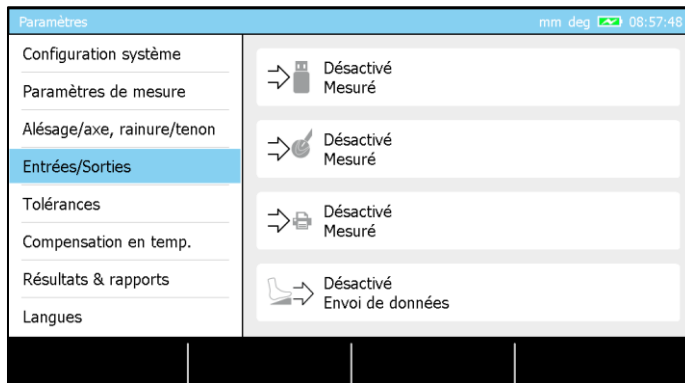

9.5 Input/Outputs









All data output (send to USB,...) management can be done:

- **Automatic**

Each time a new bloc of values is created in the measurement history, the corresponding value(s) is (are) automatically sent in real time to the activated device(s).

- Manual, sending of a value**
 The last value of the history is sent to the activated device(s) when the user is pressing the key  on the keyboard
- Manual, sending all the values**
 The last value of the history is sent to the activated device(s) when the user is pressing the key  on the keyboard
- Deactivated**
 No value is sent

Definition of options	
	Sending data to USB key <div style="border: 1px solid black; background-color: #f8d7da; padding: 5px; display: inline-block;">  The USB key used has to be formatted as FAT32. For further details, please contact your local representative. </div> For further details, please refer to this chapter .
	Sending data through TLC connector For further details, please refer to this chapter .
	Sending data to printer For further details, please refer to this chapter .
	This option is useful when using the height gauge with a footswitch (a hand switch is also possible). The foot switch is a quick and easy way of getting the hands free to handle the part to be measured, when for example a batch must be controlled. This foot switch can be set in two different ways: <ul style="list-style-type: none"> • Transmission of data: It acts in the same way as the button  of the panel • Last measurement action: allows to execute infinitely the last action of the performed measurement (often a measurement action for the MH+M)

9.6 Tolerances

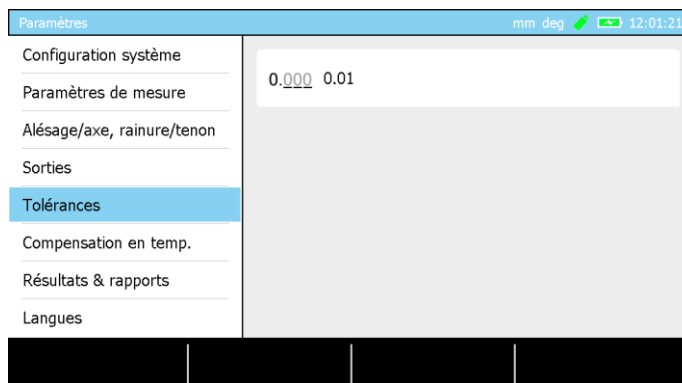

Once a sequence has been created, it is often necessary to insert tolerances for each measured dimensions. To allow the user to be faster, the nominal value for each of the program block is calculated from the corresponding measured value. This calculation is made from the help of this option (rate) which is the mean for the software to clarify the way the values have to be rounded. Note it is always possible to edit an automatically calculated nominal value later.

Examples of nominal value calculations:

Measured value	Rate	Automatically calculated nominal value
1.2345	0.01	1.23
1.2345	0.02	1.24
1.2345	0.001	1.235



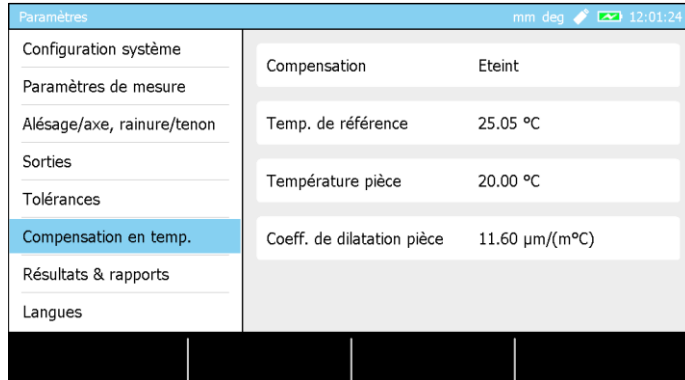

9.7 Temperature

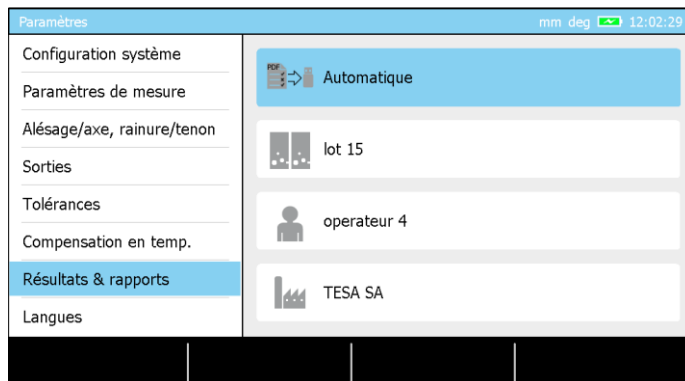

The gauge integrates a temperature compensation system that can be enabled or disabled when desired. When active, a calculation takes into account the reference temperature representing the environmental temperature in order to modify the measured values taking also into consideration the thermal expansion coefficient selected.

9.8 Results and reports



Definition of options	
	<p>Activate or deactivate the creation of reports in *.pdf format on the USB stick. The creation can be:</p> <ul style="list-style-type: none"> • Automatic at the end of the execution of a measurement programme • Manual by choosing the corresponding context-based action <p>For further information, please refer to this chapter.</p>
	Batch name to be displayed in the header of the *.pdf measurement report
	Operator name to be displayed in the header of the *.pdf measurement report
	Company name to be displayed in the header of the *.pdf measurement report

9.9 Languages

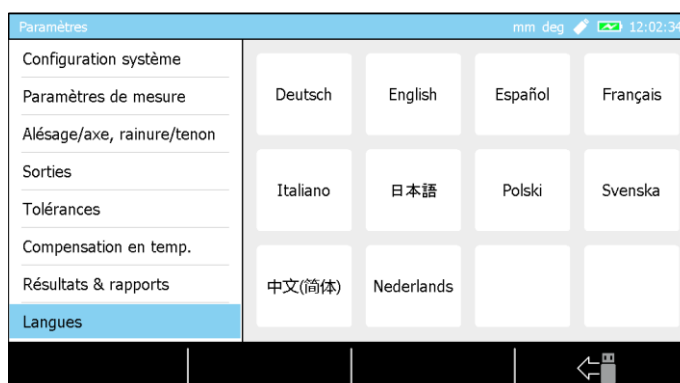

You can easily change the language by selecting your desired option. The language of the control panel will immediately change.

9.10 Customised language

In addition to the basic languages, it is possible to personalise the language of your height gauge. To do so, please contact the TESA team or your local reseller.

10 INITIALISATION

10.1 Concept

In general, the initialisation process is the first step after turning on the instrument.

No.	Description
1	Height gauge frame
2	Probe support
3	Probe
4	Cast-iron base
5	Granite table
6	Reference mark
7	Sensor
8	Increments
9	Glass scale

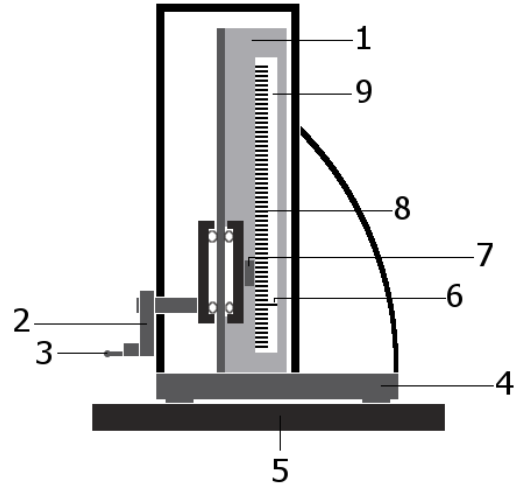

The probe support (2) is directly linked to a carriage system with an opto-electronic sensor (7) on it. As soon as the instrument has been turned on, this non-contact sensor will read the incremental divisions (8) on the glass scale (9) at all times. One of these increments is considered as the reference from which the height gauge will always calculate its position. This mark is called the reference mark (6).

The initialisation process therefore consists in moving the sensor in front of the reference mark, which is located approximately at 15 cm from the instrument base.

10.2 Automatic process (MH+M)

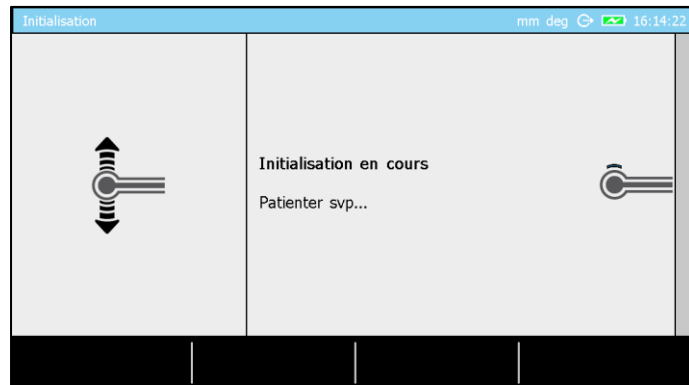

Once the height gauge is turned on and the software is loaded, the initialisation page is accessed and the height gauge automatically starts to search the reference mark. It will first move up approximately 15 cm. If the reference mark is not found or the upper limit of the instrument is reached, the sensor will move down. The process is finished once the sensor has detected the reference mark on the glass scale.

10.3 Manual process (MH)

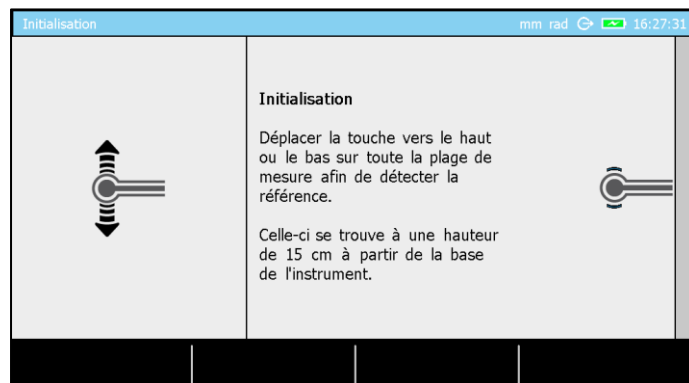

The concept is the same for manual height gauges. However, the user has to move the probe (and also the sensor integrated in the instrument) himself in order to detect the reference mark on the glass scale.

11 DETERMINATION OF THE PROBE CONSTANT

11.1 Masterpiece

Each height gauge is provided with a standard, also called master piece.



It is necessary to use this accessory with most of the measurement modes integrated in the MICRO-HITE and MICRO-HITE+M height gauges.



Calibration with groove of the master piece



Calibration with rib of the master piece



The master piece has to be as clean as possible when it is used, as it is, to a large extent, the measurement of this tool that will determine the accuracy of the results obtained later.

In order to allow the user to carry out measurements without any time-consuming calculations, the constant of the probing system is determined on the master piece, whose dimension is known. By combining 3 standards of which it is constituted, it represents an internal or external dimension of 12.7 mm / .50000 in.



It is important to only use the master piece provided with the height gauge. TESA do not guarantee correct functioning of the instrument if it is used with another master piece than the one provided by default.



The final inspection and the certificate of the instrument both refer to this master piece.

11.2 Concept

When measuring elements that require probing in two directions (for further details, see this [chapter](#)), it is necessary to take into account the probe constant.

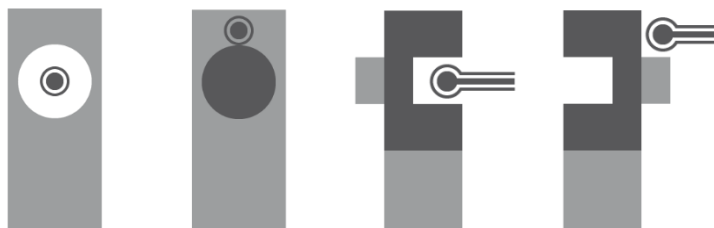

Elements that require two probe hits: bore, axis, groove, rib

The probe constant is a permanent correction factor. It is calculated by the control panel after master piece measurements, then saved and automatically taken into account during the next measurements.

The probe constant considers and compensates the main influencing factors such as:

- Diameter of the used ball or disc probe
- Elastic deformation of the probe and its support due to the measuring force
- Hysteresis error of the measurement system



Each time the measurement conditions change, the probe constant has to be determined again. The main causes of modification are:

- Turning off the instrument
- Probe change
- Probe position modification
- Measurement mode change

In case the measurement sequence does not require the use of the probe constant (for further details, see this [chapter](#)), all values are offsetted from the radius of the probe. This is the *ST1* mode.

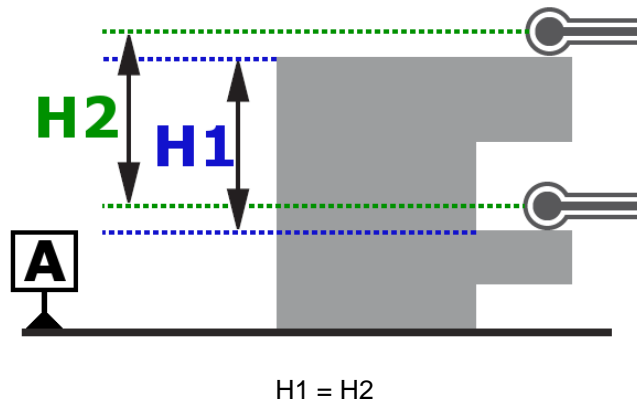

If probing in two directions is accepted in the same measurement sequence, this is the case in particular thanks to the compensation of the ball-tip radius in the probing direction. This is the *ST2* mode.

Without compensation of the ball-tip, the displayed value in the case below would be $H2$, although the required value is $H1$.

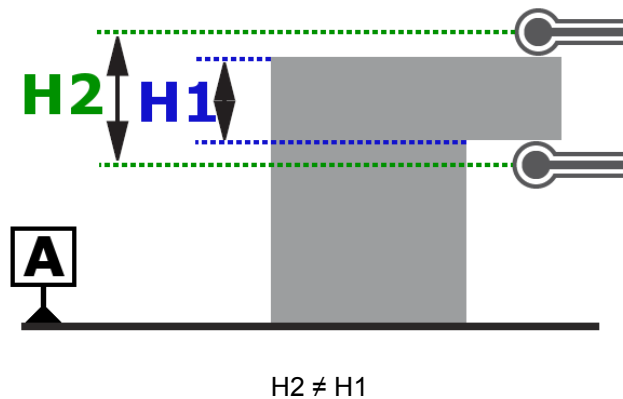

Schema representing the compensation of the ball-tip:

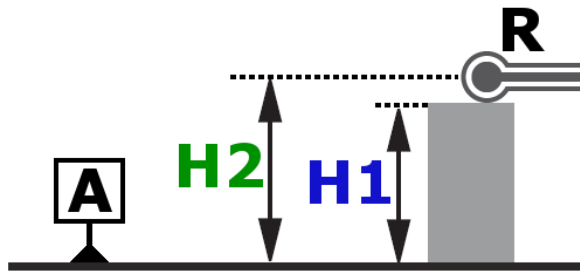

In order to determine the right point, each height H1 is recalculated according to H2 (which corresponds to the centre of the ball-tip) and the radius R of the insert (defined when detecting the probe constant).

11.3 Procedure

There are several processes to determine the probe constant. The TESA master piece design has been thought to minimise the determination time and avoid any errors that could occur when moving the master piece during a sequence.

The calibration procedure of the probe (or determination of the probe constant) requires at least two probe contacts for each measurement point.

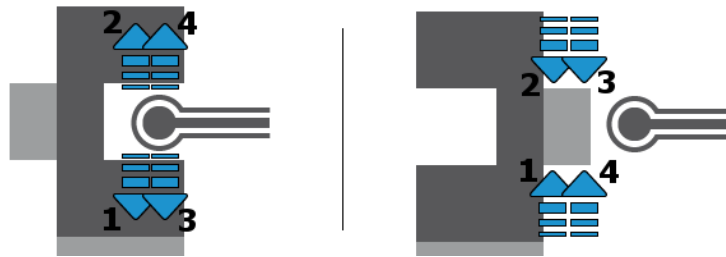

The difference between the two values obtained for each point cannot exceed a maximum value that depends on the selected resolution. If it is higher than this limit value, the difference is displayed. The user then has the choice to accept it and bypass the process with **▶▶** or to restart the process for a new measurement. If the user accepts the result, the number of digits after the comma will be reduced to be in line with the probe constant.

11.4 Steps

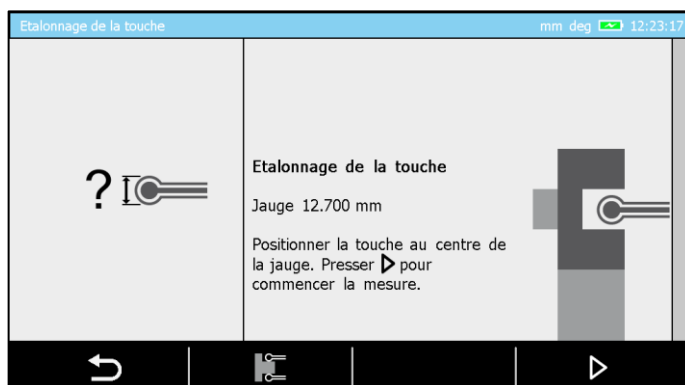

Each time the procedure for determining the probe constant is started, the above page is automatically displayed.



If you are using a motorized height gauge, a warning message will be displayed. Before activating the process for automatic determination of the probe constant, the insert must be positioned at the height of the master piece. As this displacement is done automatically, the following message will be displayed to avoid any collision with another object:

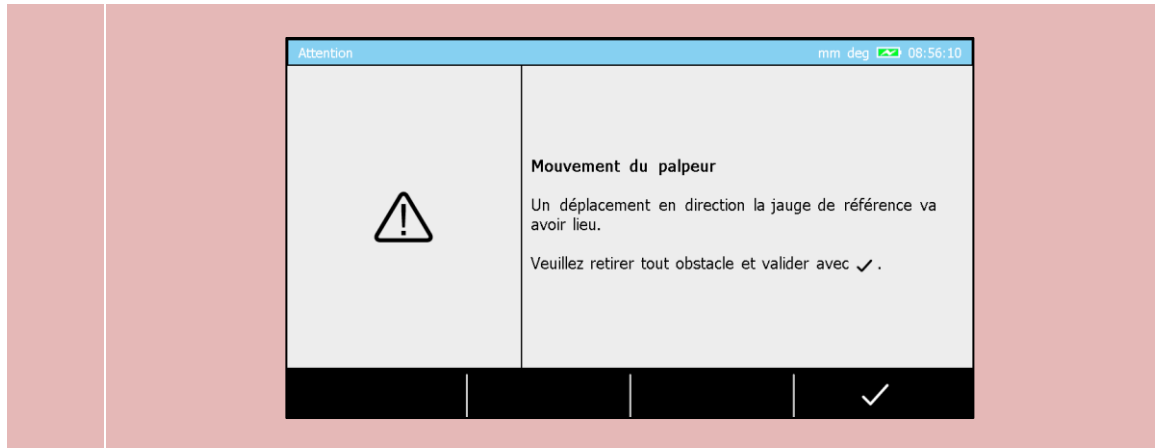

This example shows a page presenting a procedure defined for a motorised MICRO-HITE+M height gauge. When using a manual instrument, the points have to be measured using the handwheel and moving the probe from top to bottom.

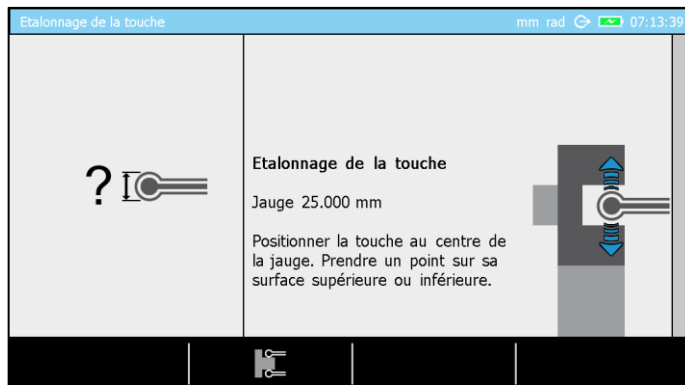



If the instrument is motorised, the procedure can be started clicking on on the keyboard or on the screen.

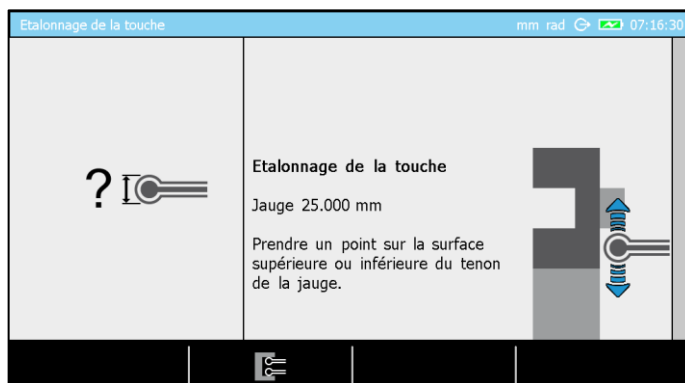

When using a motorised instrument, the insert is automatically positioned at the height of the centre of the reference when the user activates the process for determining the probe constant. This height can be configured in the system options .

The groove measurement process is active by default. Most of the time, measurements are carried out using a ball probe. However, if the user wants to define the probe constant by measuring the rib of the master piece, the user first has to change the mode by pressing the key .



Definition of keys	
	Change the process for a definition of the probe constant using the rib of the master piece.
	Change the process for a definition of the probe constant using the groove of the master piece.

Once the process is finished and the probe constant defined, a calibration block is automatically created in the measurement list of the mode. The measurements can then start in ST2  mode. The next step is to define the reference as shown in the following image.

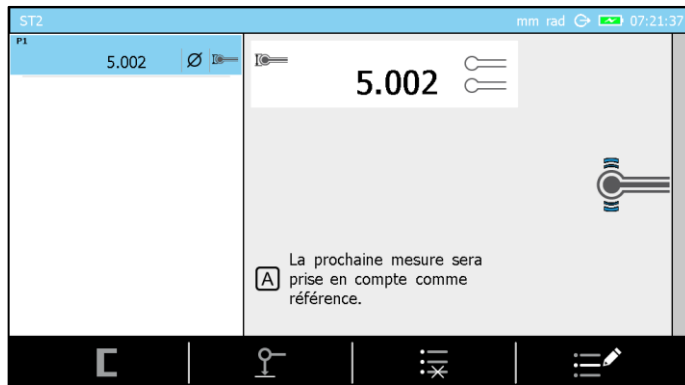

12 PRINCIPLES OF MEASUREMENT

12.1 Generality

Before using the MICRO-HITE or MICRO-HITE+M height gauge, it is important to remember that the way in which the values are measured is determined by the measurement problem. It is essential, that the user can define the nature of the measurement process according to the application, in order to quickly get reliable results.

In general, it is important to ask yourself the following basic questions:

- Does the measured value require a single or double probe hit?
- Does the measurement require an inversion of the probing direction?
- Do you have to measure with or without detection of the culmination point?
- Does the measurement sequence have to take into account only one (1D) or two coordinates (2D)?
- Which accessory fits the most with the desired measurement?

These questions are the first step to guarantee ease of measurement with correct metrological results.

12.2 Probe support

It is very likely that during the use of the height gauge, the type of application the user will be confronted will imply accessories changes in order to guarantee a reliable and precise measurement. Mounting or removing a probe or probe support is a process that requires to be careful and done in a correct way. Indeed, not mounting it correctly could lead to significant measurement errors.

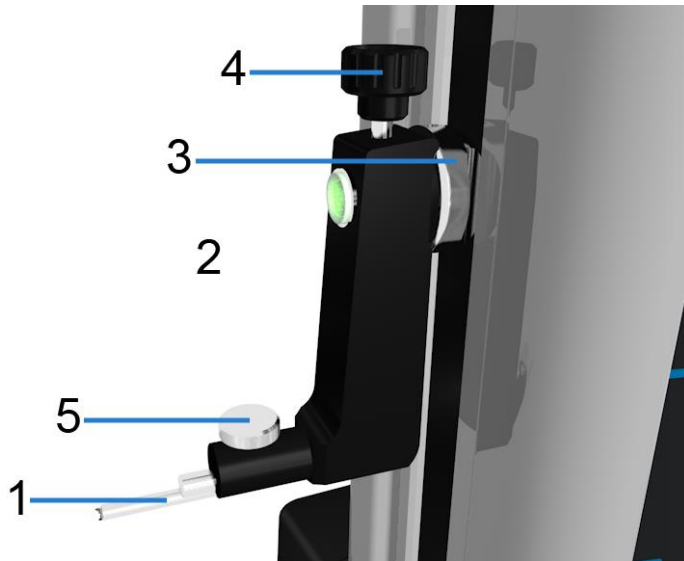

 In order to guarantee the reliability of the measured values, it is necessary that the following condition is met: the probe 1 has to be firmly attached to the probe holder 2, which is fixed on the mounting shaft 3. Make sure that the two screws of the probe holder 4 and 5 are tightened. This procedure is the same for all types of probes and supports.

12.3 Measurement modes

Once the workpiece and the wanted dimensions to be measured are known, the user has the possibility to choose among several modes:



ST1
Measurement with unidirectional probing



ST2
Measurement with bi-directional probing

MAX, MIN, Δ



Detection parallelism errors



PERPENDICULARITY

Measurement of perpendicularity and straightness errors



ANGLE

Angle measurement



CALCULATOR

Allows you to calculate by manually entering the values or using the results of previous measurements.

12.4 ST1 & ST2 philosophy

The two main modes integrated in the height gauge range are defined by the names *ST1* and *ST2*. These are the most frequently used modes. They can directly be selected via the main menu of the measurement software, which can be displayed at any moment by pressing key .

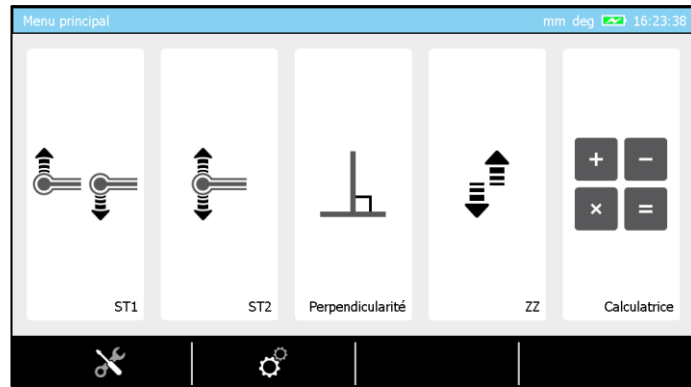

The major difference between these two measurement modes is closely linked to the features (height, diameter etc.) that will be determined during one measurement sequence. The determination of certain features does not require an inversion of the probing direction, while others entirely depend on it.



Mode	Description
ST1	<ul style="list-style-type: none"> • Lengths measurement in only one probing direction. • The calibration of the probe is not necessary.
ST2	<ul style="list-style-type: none"> • Lengths measurement in two probing directions. • The calibration of the probe is mandatory.

Each one of the two modes has been developed in order to best suit the different application cases and possibilities of use. The flexibility of mode *ST2* allows you to measure any elements, while *ST1* mode minimises the time of access to the measurement (avoiding the probe calibration process) and allows you to use accessories that cannot be easily calibrated with the master piece.

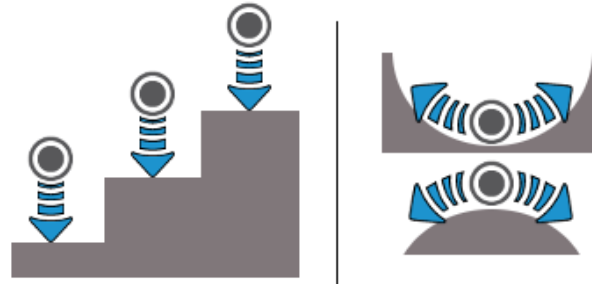

Measurement without inversion of probing direction

In the above examples, all heights are measured by down hits. All measurements therefore have a similar probing direction.

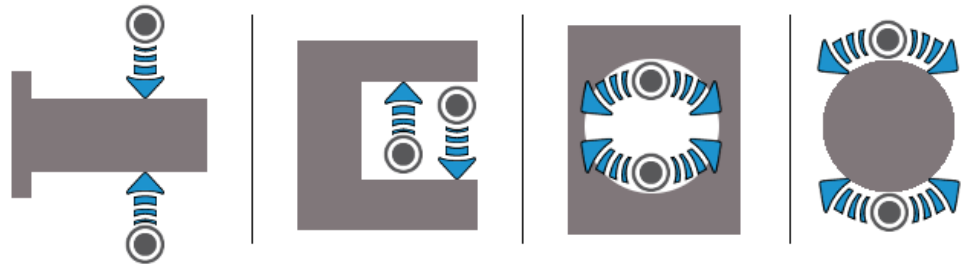

Measurement with inversion of probing direction









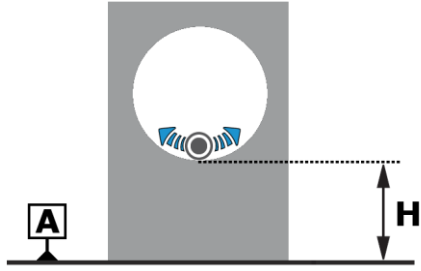

The above examples show that the measured elements require two hits, one by pushing upward and one downward. This is called a measurement that requires an inversion of probing direction as the two measurements have an opposite direction.

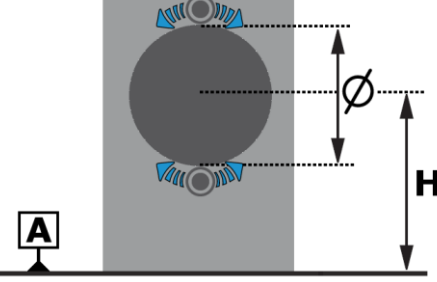

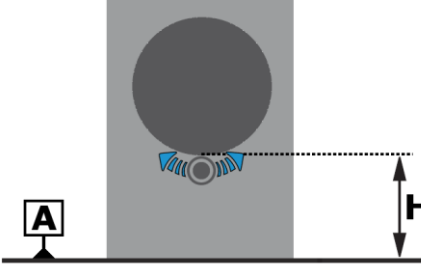

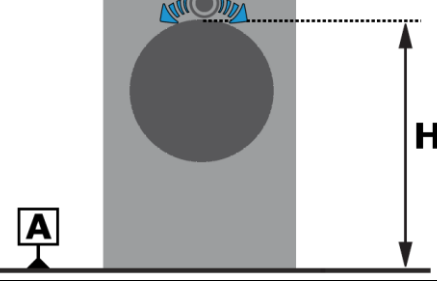

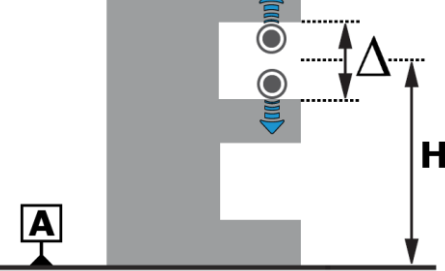
12.5 Measurement functions

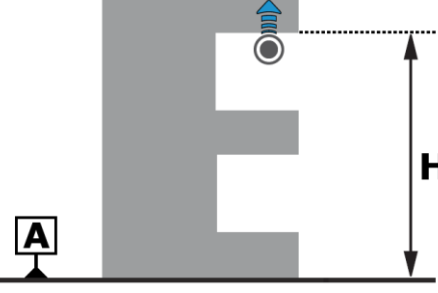
The list of measurement functions is defined by two types of keys:

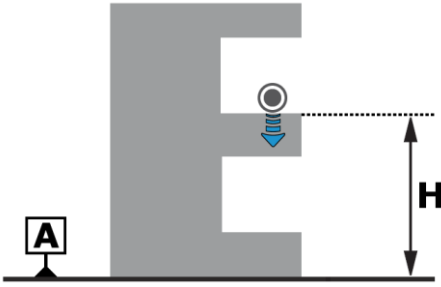
- Action keys (single or double probing)
- Calculation keys

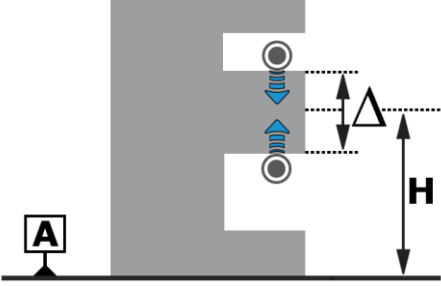
Action keys	Measurement example
<p>Bore measurement</p>	
<p>Measurement of an upper internal culmination point</p>	

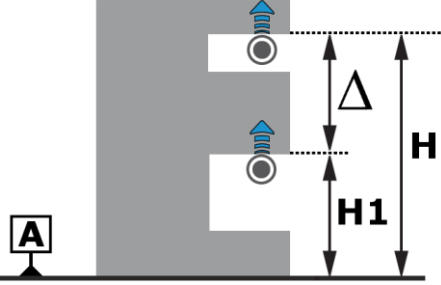
 <p>Measurement of a lower internal culmination point</p>	
 <p>Axis measurement</p>	
 <p>Measurement of a lower external culmination point</p>	
 <p>Measurement of an upper external culmination point</p>	
 <p>Groove measurement</p>	
 <p>Upper point measurement</p>	

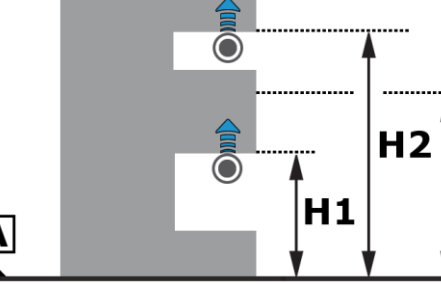
 <p>Lower point measurement</p>	
 <p>Rib measurement</p>	
Calculation key	
 <p>Difference between two values</p>	
 <p>Average between two values (H)</p>	

12.6 Manual single probing (MH)

Manual probing with one hit corresponds to the measurement of a height by establishing contact between a probe and a flat surface. This process depends on the user, as they have to move the probe at all times using the handle provided for that purpose.

 **In noisy environments, the beep tone is often not loud enough to provide clear information during the measurement. The LED located on the shaft of the probe support gives you this information visually and close to the measurement.**

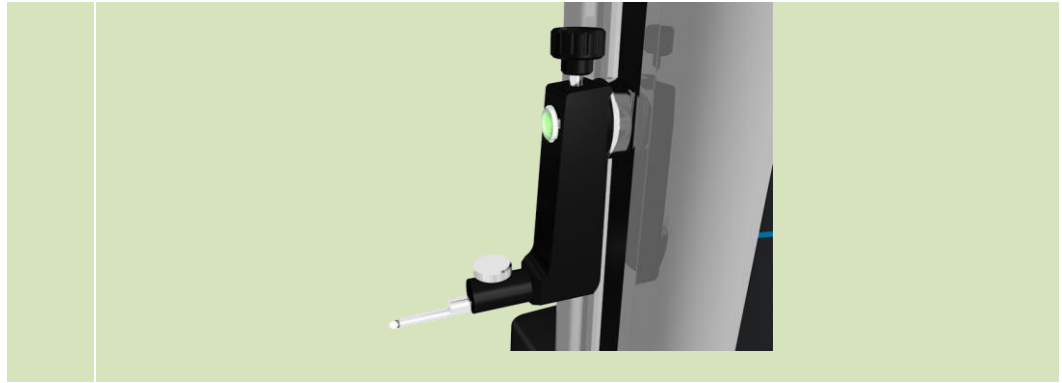

Process

1. Move the probe using the handwheel. Make sure you do not hit anything (probe, probe support etc.) during the movement.

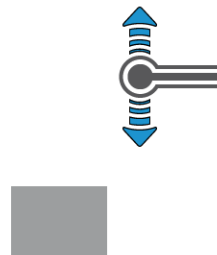

2. Position the probe close to the point to be measured.

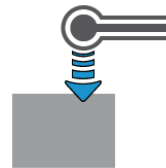

3. Once the location of the measurement is clearly defined, put the probe in contact with the surface. Continue to apply pressure on the insert (and make sure that the strain gauge is still in the green zone) until the point is captured.

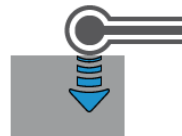

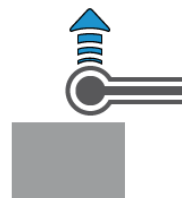

4. Release the system, so that the probe is not in contact with the workpiece any more.

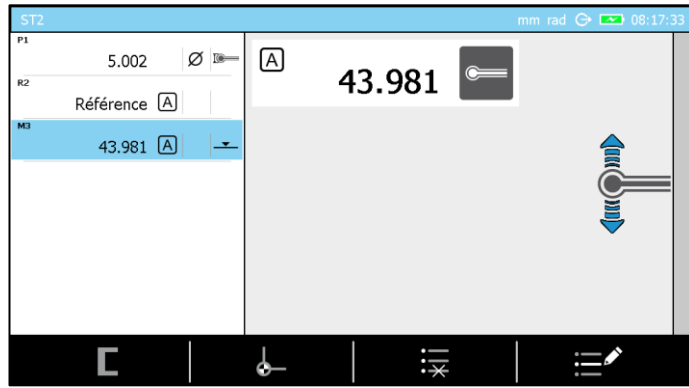

5. Visualise the result on the screen.



Note that a single probing block is created with the icon  (or ).

6. Proceed the same way for the next measurements, regardless of the probing direction.

12.7 Automatic single probing (MH+M)

The automatic single probing process is completely automatic, once the user has chosen an action from the control panel keyboard or via the displacement handle.

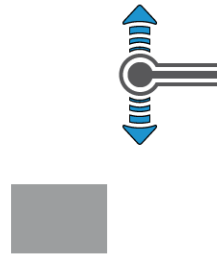

Process

1. Position the probe close to the zone to be measured using the handle on the measuring carriage or the rotary control handle.

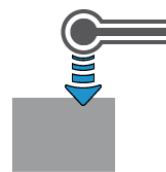

2. Make sure that there is no element between the probe and the zone to be measured that could impede the displacement of the probe.



3. Start the measurement by activating the key ,  or start the measurement directly using the rotary control handle ([chapter 2.5](#)).



4. As soon as the probe gets in contact with the point to be measured, the system ensures a constant probing force. After a stabilisation period, the measurement will be saved and then displayed on the control panel. The LED lights up briefly at the same time as the beep that indicates the end of the measurement.

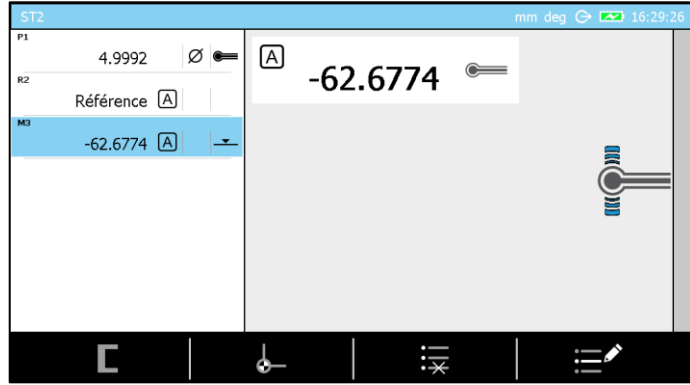

5. As soon as the measurement is finished, the probe will automatically retract. The retract distance is defined in the system parameters.

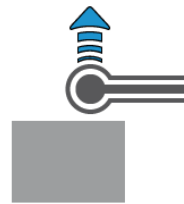

6. Proceed the same way for the next measurements.

12.8 Static culmination point (MH), bar graph

The concept of the static detection of the culmination point is defined by its way of determining the max. or min. height of the selected bore or axis. Unlike the procedure described [here](#), the displacement of the workpiece back and forth is only used to position the probe at the centre of the element. At this time, no measurement is carried out. The workpiece is no longer moved (static measurement). At that moment, the culmination point(s) are measured by probing up/down.

Before starting the procedure, it is important to make sure that the “static measurement” option has been correctly configured in the system options .

Process

1. Place the probe inside the bore.



2. Displace slightly the probe to one side in order to locate visually on one side of the searched culmination point.

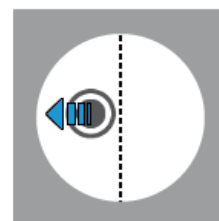

3. Move the probe up or down in order to establish contact with the workpiece.

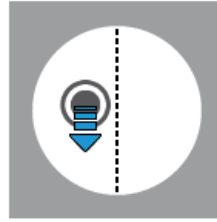



4. Once the contact is established, continue to apply pressure in order to place the strain gauge (see this [chapter](#) or this [chapter](#)) in the green zone. Ideally place the strain gauge in the centre of the green zone in order to allow the measuring carriage to move correctly from one side of the culmination point to the other (maintaining the strain gauge always in this green zone).



5. Lock the locking ring. At that moment, the software will start the procedure to measure a culmination point.



The software remembers what was the selected process when calculating the last culmination point. This process is automatically enabled for the next measurement. If you would like to change it, you can press the key  or  from the control panel.

- The software requires to move the probe inside the bore
- The software activates the information LED in the probe's zone
- The software displays a graph helping with positioning

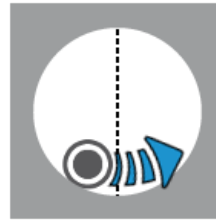

One of the graphs helping with positioning is displayed as follows:

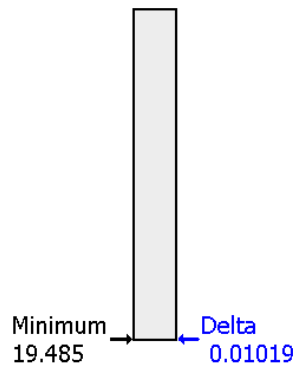

This graph allows to display the minimum/maximum position in memory as well as the difference between the current probe position and this maximum/minimum value. This delta value enables the fine positioning of the probe when it is very close to the point to be measured.

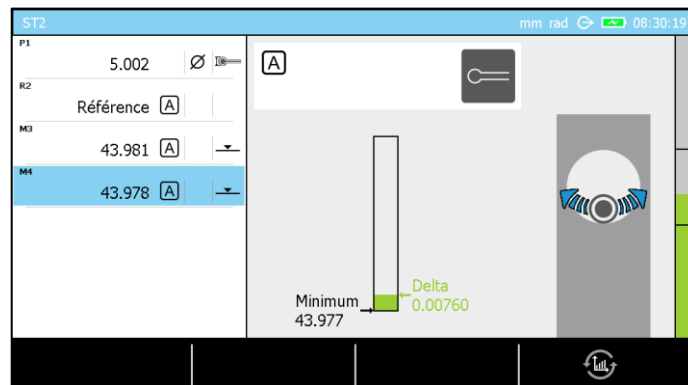

Note that the key  allows to change from one type of graph to another according to the user's wishes.

6. The probe is now in contact with the workpiece, on one side of the culmination point. The next step is to move in direction of the culmination point to be detected until the delta value increases (which means that the probe moves up in the bore, on the opposite side of the initial position regarding the culmination point).

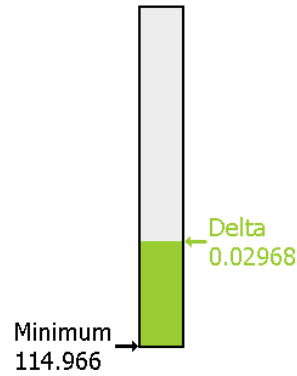

Note that the value of the culmination point in our example increases from 19.485 to 114.966. The probe is now at a distance of 0.02968 of the culmination height currently in memory (114.966).

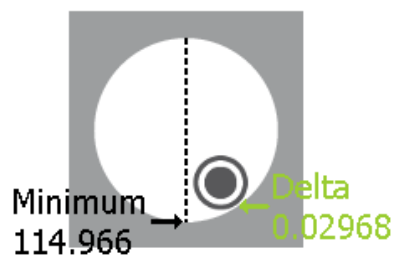

- 7. The next step consists in moving the probe back in order to obtain the smallest difference possible of delta, which means that the probe is at the minimum value or very close to it.

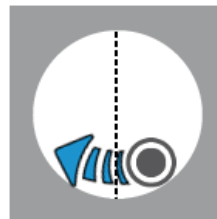

- 8. A delta value close to zero indicates that the probe is at the minimum point.

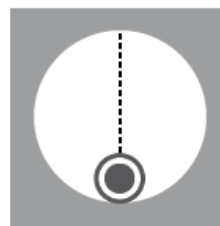

- 9. The value of the minimum has not changed. The delta value is very low now.

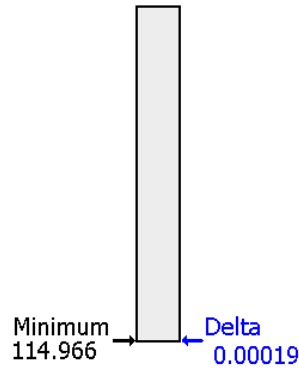

10. The next step consists of unlocking the locking ring and probing down, as the insert has been positioned at the culmination point.

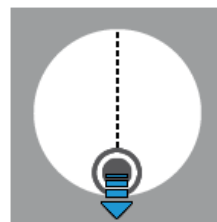

12.9 Static culmination point (MH), galvanometer

The first steps of this procedure are equivalent to the ones defined in the previous chapter (determination of the culmination point, static mode, bar graph). As steps 1 to 5 are same, the explanation of the procedure below will start at the moment the graph is displayed for the first time on the screen.

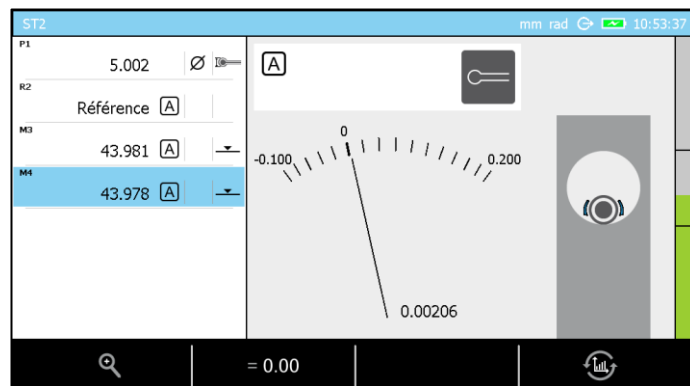

Note that the key allows to change from one type of graph to another according to the user's wishes. The two other keys allow you to change the resolution of the galvanometer and to set the position of the pointer on its 0.

6. The probe is now in contact with the workpiece, on one side of the culmination point. By default, the pointer is positioned on the 0 of the display. When the display is activated, its resolution is 20µm. The value 0.00206 corresponds to the height difference regarding the original position (which is 0).

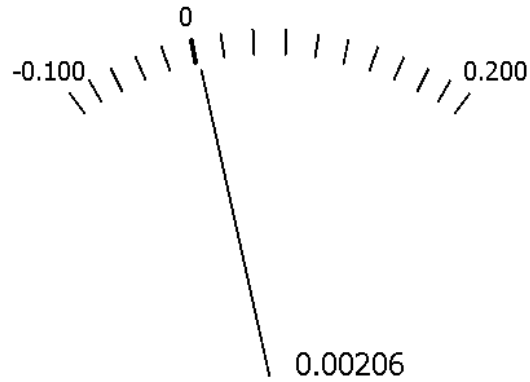

- 7. Displace the workpiece in order to move the probe in the direction of the culmination point to be detected.

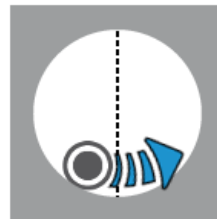

As the workpiece (and therefore the probe) is displaced, the pointer of the galvanometer will also move.

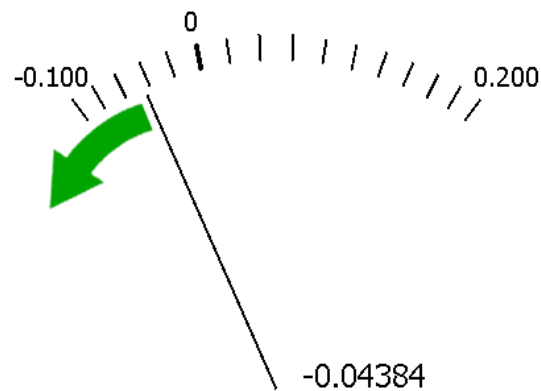

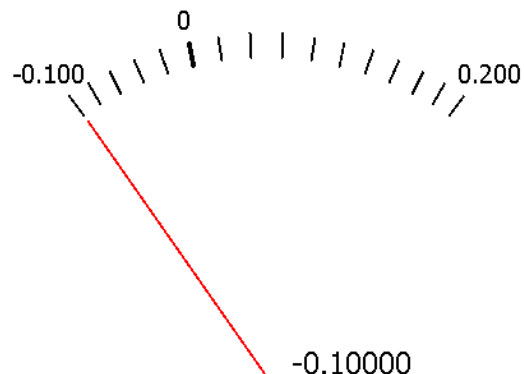

If the probe has still not moved to the inflection point (which means that the pointer will turn and move in the opposite direction) and the pointer reaches the end of the display, you have to press the context-based action key in order to position the pointer in a visible range. Below you find an example of the pointer at the end of the display.

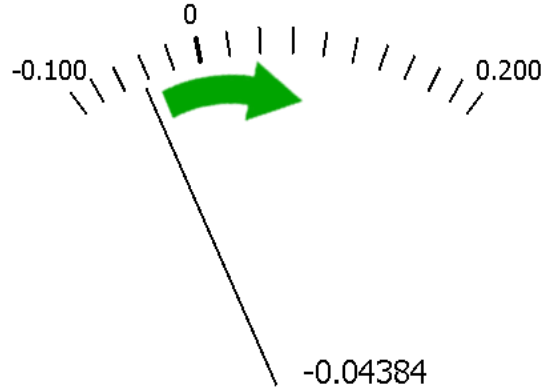

Continue to use the key  as long as you do not see any change of direction of the pointer as you are moving the workpiece.

- When the insert passes the culmination point, the pointer of the galvanometer will change its direction of rotation and move in the opposite direction.



- At that moment, you will know that you have passed the inflection point and that you have to move the workpiece in the opposite direction in order to go back to where the pointer modifies its direction again (ideally play with key  to visually position the inflection point at 0 on the display).

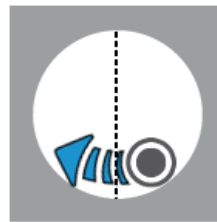

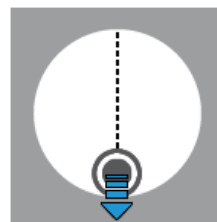

- Once you have detected the inflection point, the next step consists of unlocking the locking ring and probing down, as the insert has been positioned at the culmination point.





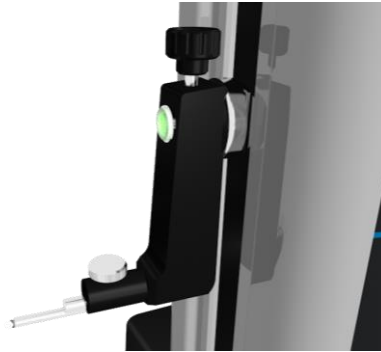

12.10 Static culmination point (MH), help LED

The use of the LED during the process of determining a culmination point in static mode offers an advantage when looking for a reliable but quick measurement. The LED positioned at the limit of the shaft that is used to fix the probe support will change its colour according to the action that will be applied on the probe.











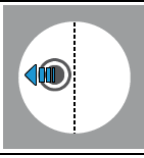
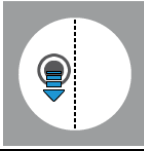



For the explanation below, we consider that the LED option has been previously activated in the menu *System options* , which is available from the main page of the software that can be accessed at any time via the key .

There are four different colours that the LED will display. Each one of it represents different information.

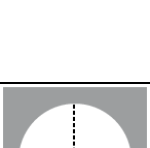

Colour	Description
	The software is ready for measurement. The process can start.
	The probe is moving in the wrong direction.
	The probe is located at the inflection point or very close to it.
	The probe is moving in the right direction. Do not displace the workpiece too quickly.

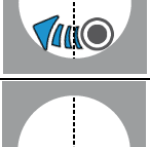
Below you will find an example describing the different steps of measuring a minimum internal culmination point. Of course all other types of culmination points can be measured in a similar way.

Step	Schema	Action	LED
1		Place the probe in the bore.	Not turned on
2		Slightly move the probe, so that it is visually placed on one side of the culmination point.	Not turned on
3		Move the probe down, so that it gets in contact with the workpiece. Once the probing force is in the middle of the mechanical range of the carriage, block the locking ring.	
4	-	Observe the help image on the right side of the screen and verify if the software suggests to measure an internal culmination point. If that is not the case, press the corresponding keyboard key to change the process.	

5		In this precise case, the software expects to detect a minimum internal culmination point. If the workpiece is moved in a way, that the probe is pulled away from the culmination point, the LED will warn you about the incorrect handling.	
6		The LED became red at step 5. Therefore, it is important to move the workpiece in the opposite direction in order to detect the inflection point. This is the correct direction and the LED becomes orange.	
7		As long as the probe has not passed the inflection point and is not “going up” on the other side of the point to be measured, the software understands that the minimum point has not yet been determined. Therefore, it is important to continue to move the workpiece until the LED becomes red (which is equivalent to saying that the probe is moving away from the culmination point).	
8		Change the direction again. Carefully, you are approaching the zone of the culmination point.	
9		As soon as you have reached the culmination point, the LED becomes green. Make sure you are at the right place by verifying the values displayed on the screen. You can then unlock the ring and measure the culmination point.	
10	-	If you continue to move the measuring probe in any direction from the culmination point, the LED will become red again.	

12.11 Bore measurement, static mode (MH)

The measurement of a bore or axis follows the same steps as the procedure described [here](#). The only difference is that the determination of the bore or axis diameter requires a probing up and a probing down instead of a single probing down as described in step 10. Thus, mode ST2  is required as probing with two contacts  up and down is required.

12.12 Dynamic culmination point (MH)

On the manual MICRO-HITE, a culmination point can be measured in dynamic mode meaning by moving the workpiece back and forth, so that the probe passes the maximum or minimum culmination point to be detected. The height of the culmination point is then measured on the fly and stored in the memory. Measurements in dynamic mode are only possible when the corresponding option has been configured in the system parameters  (for further details, see this [chapter](#)).



At each passage, a new culmination point is calculated and compared with the previous ones. If the difference between all the memorised points is above a certain limit, the measurement is considered as invalid.

Process

1. Place the probe inside the bore.



2. Displace the probe slightly to one side of the culmination point (visually).

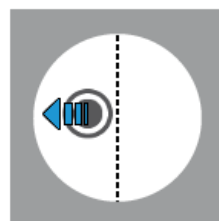

3. Move the probe up or down in order to establish contact with the workpiece.

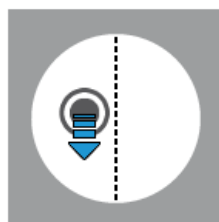

4. Once the contact established, continue to apply pressure in order to place the strain gauge in the green zone. At that moment, the software has to detect that you want to measure a culmination point and will ask you to move in the bore.

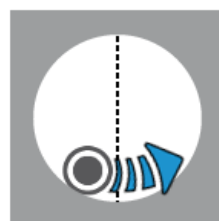

If the selected mode is not the right one (bore instead of axis measurement, or vice versa), this is the moment to select the right procedure using the keyboard. Note that the procedure selected will be stored in the memory for the next measurement.

5. Once the minimum (or maximum) point passed, the software will issue a beep. The probe is now located on the opposite side.

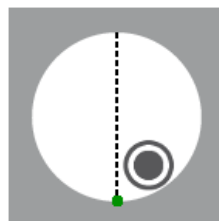

6. It is now possible to release the pressure on the probe and to remove it from the workpiece. This action finishes the process.

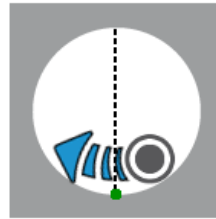

It is also possible to pass again and to move to the opposite direction again in order to define a new inflection point, which will be compared to the first one. This step can be repeated as often as you want until the pressure on the probe is stopped.



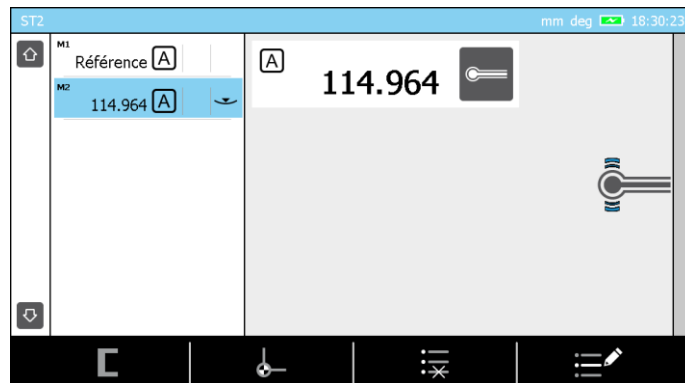

7. The result is automatically displayed on the screen.









12.13 Bore measurement, dynamic mode (MH)

Bores or axes cannot be measured in mode *ST1*  with a manual MICRO-HITE, as it requires probing in two directions. Therefore, mode *ST2*  is required.

Once in mode *ST2* , it is important to verify that the option of probing with two contacts  has been correctly selected (for further details, see this [chapter](#)). Then proceed as explained [here](#) for each upper and lower culmination point.

12.14 Culmination point (MH+M)

On the MICRO-HITE+M, the type of measurement of the culmination point is intrinsically defined by the selected keyboard action. The software knows the nature of the point to be measured from the selected process:

-  Minimum internal culmination point
-  Maximum internal culmination point
-  Minimum external culmination point
-  Maximum external culmination point
-  Bore
-  Axis

 **The dynamic mode is the only mode defining the process to determine culmination points with a motorised height gauge. It is the workpiece**

that will move and the inflection point is determined on the fly. Thus, the static mode is not available for this type of model.





Process

1. Place the probe inside the bore.

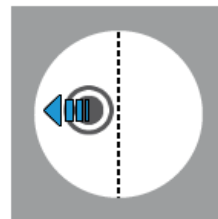

2. Displace the probe slightly to one side of the culmination point (visually).



3. Select an action key on the keyboard , ,  or . The height gauge will move in the required direction in order to establish contact with the workpiece to be measured.

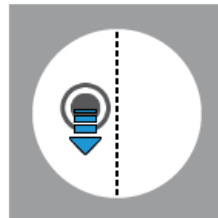

4. Once the contact is established, it is important to wait for the validation of the software in order to proceed with the displacement of the probe in the bore/axis to be measured.

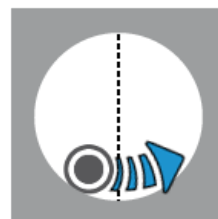

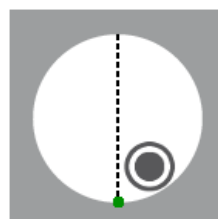

5. Once the minimum (or maximum) point passed, the software will issue a beep. The probe will retract (displacement defined in the system parameters) and stop.

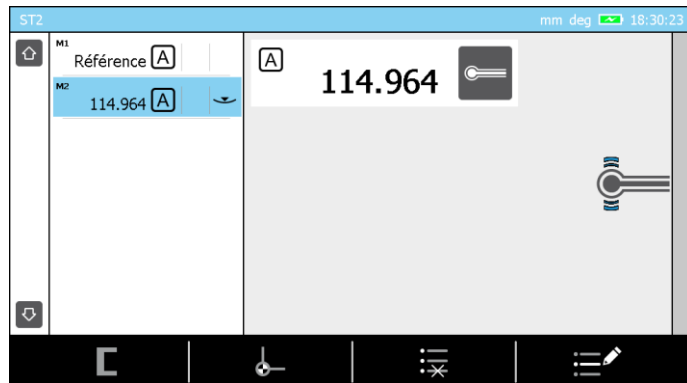

6. The result is automatically displayed on the screen of the control panel.



12.15 Bore measurement (MH+M)

The first steps of measuring a bore or axis are the same as the steps described [here](#). The only difference is the keyboard action selected. Now you have to either activate  for axis measurement, or  for bore measurement.

1. As soon as the first culmination point has been determined, the probe will automatically move in the direction of the second point in order to be positioned in contact with the opposite part of the element to be measured.

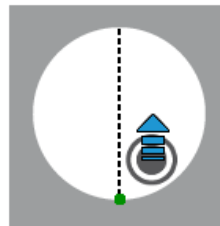

2. Once the contact is established, it is important to wait for the validation of the software in order to proceed with the displacement of the probe in the bore/axis to be measured.

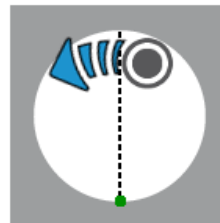

3. Once the minimum (or maximum) point passed, the software will issue a beep. The probe will retract (displacement defined in the system parameters) and stop.

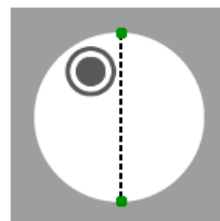

4. The result is automatically displayed on the screen of the control panel.

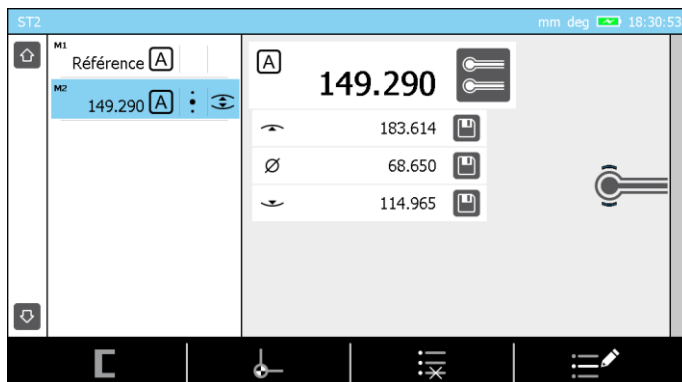

13 ST1 MODE

13.1 Generality

The access to *ST1* mode does not require the determination of the probe constant. This has a direct impact on carrying out a measurement sequence. All measurements regarding the same reference have to be carried out by probing in a direction similar to the one chosen when the active reference has been captured.

		Probing direction (during the same measurement sequence)					
Probing (capturing the reference)		•	•	•	-	-	-
		•	•	•	-	-	-
		•	•	•	-	-	-
		-	-	-	•	•	•
		-	-	-	•	•	•
		-	-	-	•	•	•

Example of a measurement sequence when the active reference has been probed down or up.

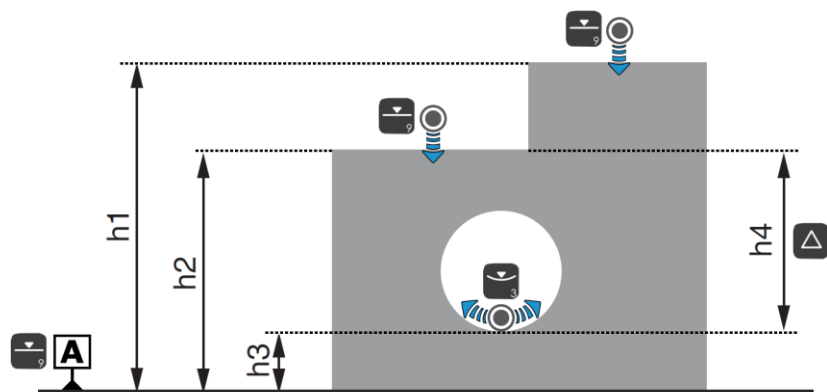

Example of measurements when the active reference has been determined by probing down.

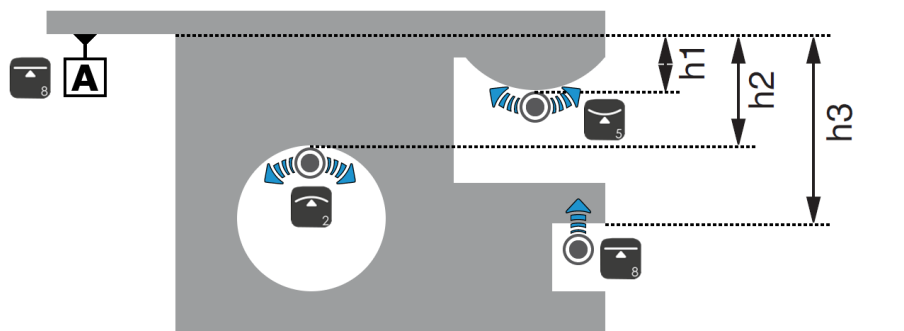

Example of measurements when the active reference has been determined by probing up.



The ST1 mode can accept several different references. This means that the measurements stored in the memory may not have been taken in the same direction if they are depending on two different references.

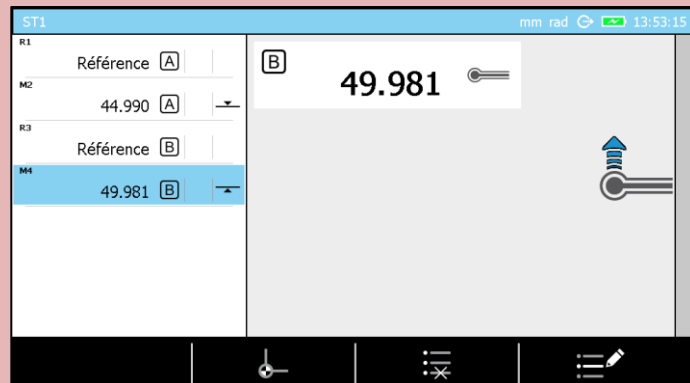

In this example, measurements M2 and M4 are probed in two opposite directions. This is possible as these measurements depend on two distinct references A and B also captured in two opposite probing directions.

This mode is accessible from the main menu by activating the key  at any moment.



13.2 Capturing the reference value

In ST1  mode, reference values are always captured with single probing.



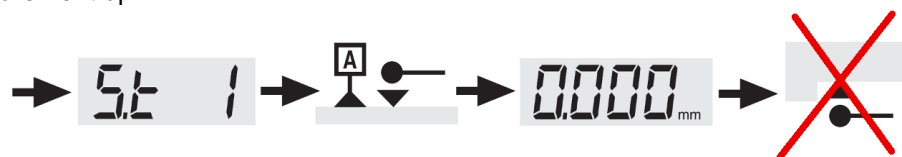

This reference value can be defined by a single probe hit (↓, ↑) or by measuring a culmination point (↖, ↗, ↘, ↙). As explained before, the probing direction used when capturing this reference value will determine the probing direction of the following measurements.

Thus, the following process is impossible as the reference is probed down and the measurement up:



Any measurement with inverted probing direction compared to the direction defined when the reference value has been captured, will generate a warning beep. Therefore, no point is stored in the memory.

13.3 Reference value management



In *ST1*  mode, the reference values are managed the same way as in *ST2*  mode.
For further details, see this [chapter](#).



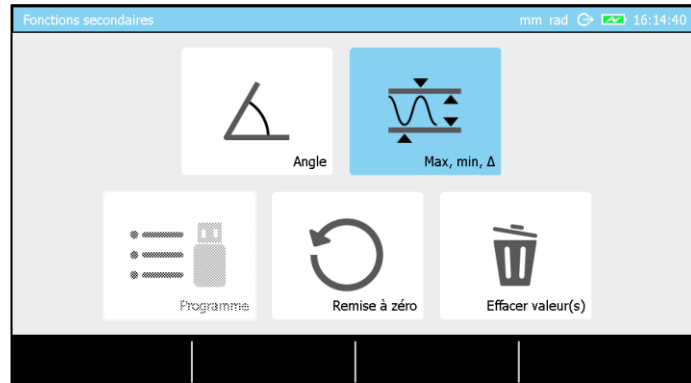

13.4 Secondary functions *FX*

In *ST1*  mode, secondary functions are accessible via key .



- Angle measurement (for further details, see this [chapter](#))
- Min, max, Δ (for further details, see this [chapter](#))
- Programs' management and tolerancing (for further details, see this [chapter](#))
- Delete all measurement blocks and delete reference values in the memory
- Delete one or several measurement blocks

 **The *Min, Max, Δ*  mode is only active and selectable if the reference value has already been measured before.**

 **Once the *Angle*  or *Min, max, Δ*  mode selected, it is possible to go back to *ST1*  one by pressing the key .**

13.5 Context-based actions

All actions of *ST1* mode, displayed and usable from the bar at the back of the screen are also displayed and usable with *ST2* mode. *ST2* mode integrates the actions of *ST1* mode.
For further details, see this [chapter](#).

14 ST2 MODE

14.1 Generality

Each time when entering ST2 mode, it is necessary to calibrate the probe . Once this has been carried out, you can either probe up or down for any measurement sequence.

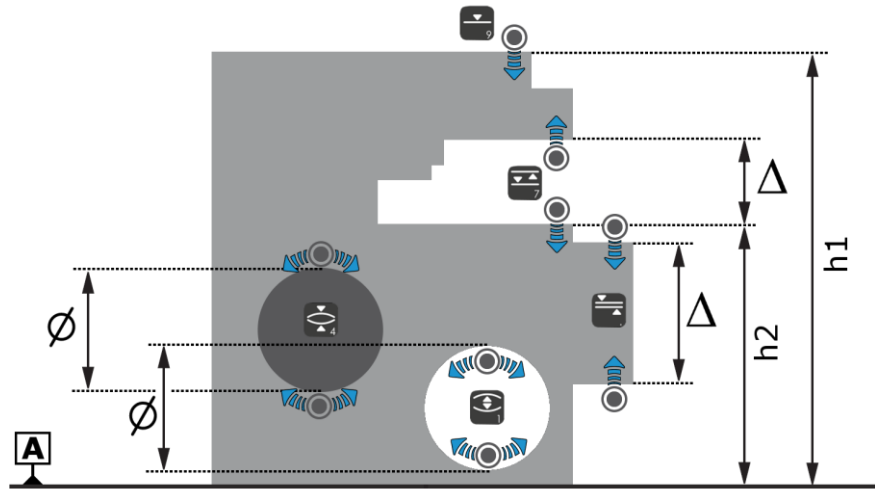

Examples of a measurement sequence in ST2 mode

This mode is accessible from the main menu by activating the key at any moment.



14.2 Probe calibration

When entering ST2 mode, the probe calibration process starts automatically (for further details, see this [chapter](#)).

The procedure for determining the probe constant is only re-executed if the user leaves the ST2 mode and enters in another mode (ST1 , Perpendicularity). Thus, an intermediate modification of a system parameter (in) or the use of the integrated calculator does not imply a re-determination of the probe constant.

14.3 Capturing the reference value

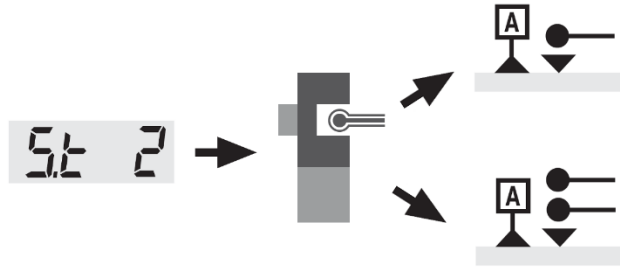

When entering ST2 mode, once the probe calibration has been performed, the reference values can be captured through single or double probing.

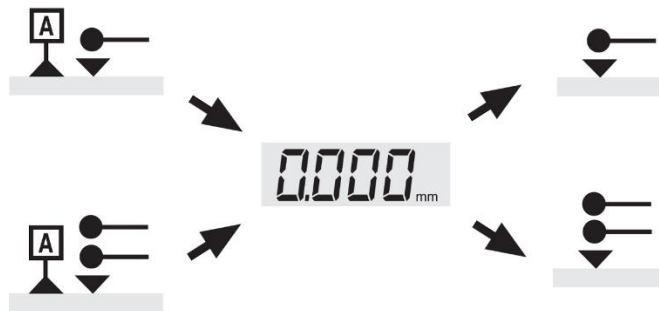

Once this reference value has been captured, the measurements can be carried out with single or double probing.



14.4 Single & double probing

The concept of single and double probing has been developed in order to allow the direct measurement of certain elements and quick access to their features. While single probing  enables only height measurements in order to gain some time, double probing  is the way to minimise the number of measurement steps and to improve cycle time. Therefore, everything depends on the application.

Note that double probing allows you to position a reference value at levels that would be impossible in *ST1*  mode:

- Centre of groove or rib
- Centre of bore or axis

Other configurations are also possible (example: between two circles) but used less frequently.

As each application is different, it is the responsibility of the user to define the most appropriate measurement steps. In many cases, a similar result can be reached via two measurement sequences. Only their steps are different.

In order to illustrate single and double probing, two different measurement procedures with the same result are shown below. Note that each measurement block corresponds to one step that has to be carried out independently of the others.

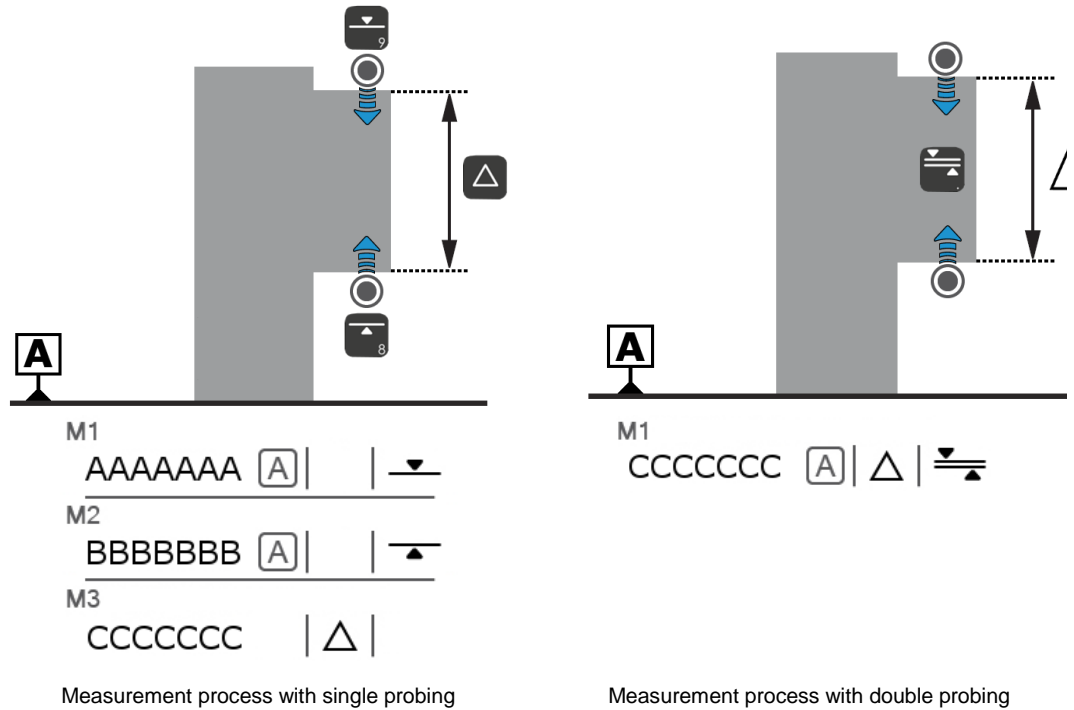

The two examples above clearly show that in certain cases, it is better to go for double probing. The first solution requires 3 measurement blocks (and therefore two different measurements and a calculation) to get a result, while the second one only requires one.

! It is important not to mix single/double probing and ST1/ST2 concepts. Here is a summary giving the overview:



ST1 mode	<ul style="list-style-type: none"> • Single probing only • Probing in reference's direction only
ST2 mode	<ul style="list-style-type: none"> • Single or double probing possible

On motorised MICRO-HITE+M height gauges, the number of probe contacts for measuring an element is intrinsically linked to the activated key on the control panel (for further details, see this [chapter](#)) or the action run with the rotary control handle (for further details, see this [chapter](#)).

For example, corresponds to a up single probing, while allows you to start a double probing measurement going up and down.

On the other hand, the manual MICRO-HITE height gauges behave differently. Their **ST2** mode allows to choose the number of probe contacts after which a measured element will be calculated: one or two hits.

Icon	Description
	Two probe hits
	Two probe hits The upper point is measured.
	Two probe hits The lower point is measured.
	Two probe hits Both points are measured.

	One probe hit
	One probe hit The point is measured.

You can change from one probe hit to two (and vice versa) by pressing the key on the main result bar.

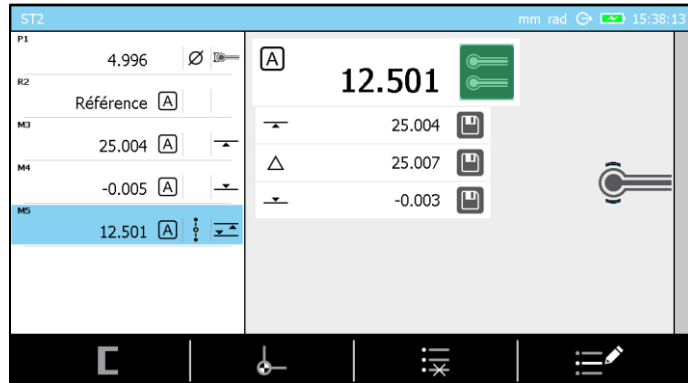



14.5 Secondary results

When measuring an element by double probing, several results are displayed on the screen. In addition to the main value, 3 secondary values can also be available (in green below).

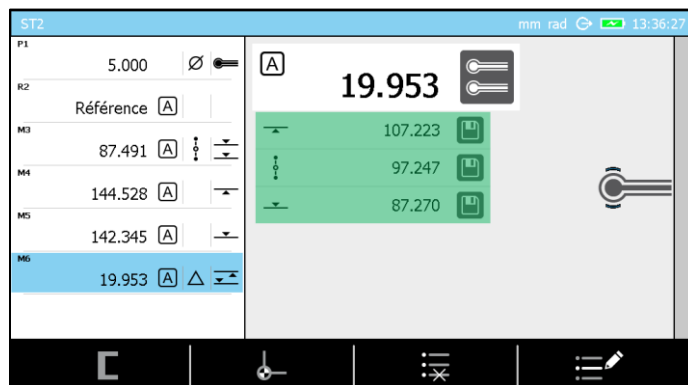
The main value is automatically saved in the measurements list, which is not the case for the secondary results.



In the screenshot above, the secondary values are:

Icon	Description	Value
	Probing up	107.223
	Midpoint between the two measurements	97.247
	Probing down	87.270

In certain cases, a secondary result could also be a wanted one. Click on the key , which allows you to save the value in the measurements list.

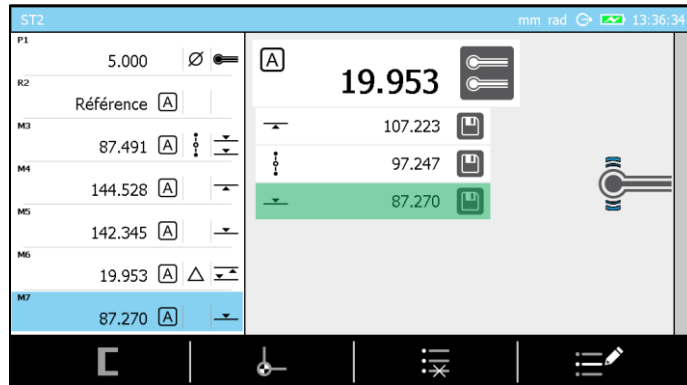

The image above shows that the result corresponding to a down probing has been stored in the measurement list.

14.6 Secondary functions FX

In ST2 mode, secondary functions are accessible via key .

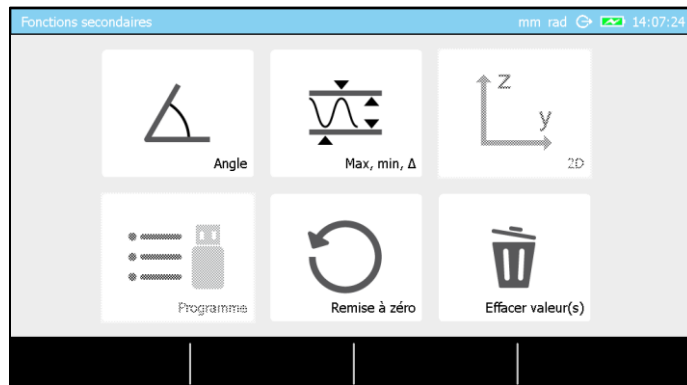

- Angle measurement (for further details, see this [chapter](#))
- Min, max, Δ (for further details, see this [chapter](#))
- Measurements in 2 dimensions (for further details, see this [chapter](#))
- Programs' management and tolerancing (for further details, see this [chapter](#))
- Delete all measurement blocks and delete reference values in the memory
- Delete one or several measurement blocks



The *Min*, *Max*, Δ and *2D* modes are only active and selectable if the reference value has already been measured before.



Once *Angle* , *Min*, *max*, Δ or *2D* mode is selected, it is possible to go back to *ST2* mode by clicking on key .

14.7 Indirect reference (PRESET)

This function allows you to enter numerical values, in particular for capturing dimensions with a reference point that cannot be probed directly. The distance between the chosen surface to be probed and the reference point used has to be known at least in the form of a theoretical dimension with a positive or negative sign. This indirect reference can be found above or below an element accessible for probing.

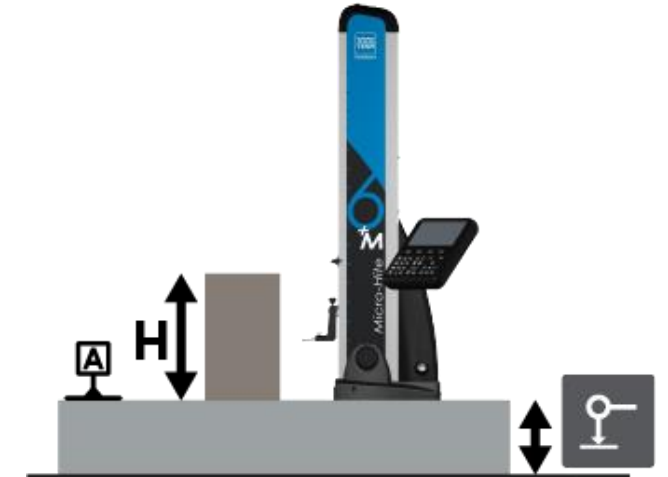

The indirect reference is located below the level of the instrument base

1. In *ST1* or *ST2* mode, the user has to press  first, in order to manually enter the preset value.
2. The following step is the definition of the measurement reference. In our example, this reference value is only a fixed point used to define the indirect reference.

Once steps 1 and 2 are finished, all measurements will be calculated according to the indirect reference A.



The option can only be selected when the software requires to define a measurement reference. Any modification of the value of the indirect reference will implicate a redetermination of the measurement reference.



For further details, see this [chapter](#).



14.8 A&B references management

The MICRO-HITE and MICRO-HITE+M offer the possibility to work with two measurement references called A and B at any moment. You will automatically be asked to define a reference in the following situations:

Mode	Description
<i>ST1</i>	When you enter into this mode for the first time
<i>ST2</i>	Following a calibration of the probe

At the same time, it is also possible to force the definition or re-definition of a measurement reference by:

- pressing the key , which will restart the process of determining the active reference
- pressing the key  or  on the control panel during 3 seconds. As a result, the last measurement block in the measurement memory (calculated or measured) is taken into account as active reference value.

A reference can be activated by pressing the key  or  on the control panel. This is only possible if the reference value has been defined previously. Otherwise, an error beep will warn you that this reference cannot be used for the moment as it has not been defined yet.

14.9 Delete last measurement block

It is possible to delete the last measurement block in the memory at any moment via the key . This deletion is independent from the selected block(s) in the measurements list.

14.10 Edit a measurement block

The name of a selected measurement block in the history can be edited at any time

with the button .

 **When calculating, it happens that the name of the newly created block is automatically defined according to the previously selected blocks for calculation (example “M3-M5”). This name is informative and can also be modified via the editing key.**

Below an example of introducing a block name:



On the top right side of the screen, the total number of characters available for determining the name as well as the number of characters already used is defined.

14.11 To run a probe calibration

The key  will allow you to force a probe recalibration.

14.12 Distance between two heights

It is possible to calculate the distance between two heights (calculated and/or measured) using the key  of the control panel. However, it is important to know prior to the measurement which results (measurement blocks of the list) have to be taken into account during the calculation. There are two options for the user.

Case	Description
Only one block of the memory is selected (regardless of which one it is)	Regardless of the block that has been selected, it is the distance between the two last valid blocks in the list that is calculated. $M_{\text{last block}} - M_{\text{second last block}}$
Two blocks of the list are selected	The distance is calculated as follows: $M_{\text{selection 1}} - M_{\text{selection 2}}$

For further details, see this [chapter](#).

14.13 Average between two heights

It is possible to calculate the average of two heights (calculated and/or measured) using the key  of the control panel. However, it is important to know prior to the measurement which results (measurement blocks of the list) have to be taken into account during the calculation. There are two options for the user.

Case	Description
Only one block of the memory is selected (regardless of which one it is)	Regardless of the block that has been selected, it is the distance between the two last valid blocks in the list that is calculated.

	$(M_{\text{last block}} - M_{\text{second last block}})/2$
Two blocks of the list are selected	The distance is calculated as follows: $(M_{\text{selection 1}} - M_{\text{selection 2}})/2$



For further details, see this [chapter](#).

14.14 Selection of a measurement block

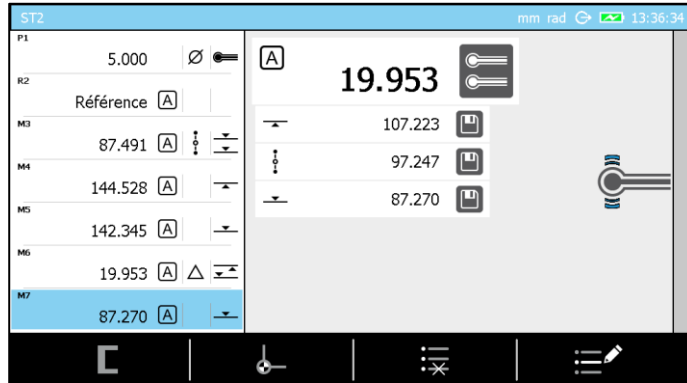
In each measurement mode, it is possible to select one of the measurement blocks from the measurements list. Selecting means to position the blue cursor on the measurement block as it is the case for the last block on the below picture.





There are two possibilities to do so:

1. Use the arrows  and  of your control panel
2. Touch the block directly on the touchscreen

14.15 Two measurement blocks selection

When a calculation involves several measurement blocks, it is important to take into account that the order in which the blocks are selected will have an impact on the final calculation (on the sign of the result).

The multiselection of blocks is mainly used to calculate a height difference  or a middle/average height .

There are two different ways for a multiselection:

1. By quickly clicking two times on the block to be selected directly on the screen.
2. By displacing the focus (blue bar) on the block and pressing the key  of the keyboard.

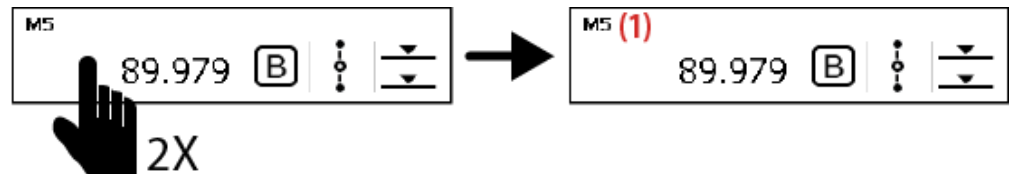

Note that selecting a block will add a (1) or (2) after the number of the block (for example M3 (1)). This number is crucial, as it directly depends on the order of selection and will play a role in the sign of the result.

 **If you would like to deselect a block, you can:**

- Quickly click two times on the selected block (touchscreen)
- Displace the selection on the block and validate the deselection using the key  on the keyboard.

15 MAX, MIN, Δ MODE

15.1 Introduction

This measurement mode is also called “continued display”. It can be defined as a mode that enables scanning a surface in order to detect parallelism errors in regards to a reference surface.

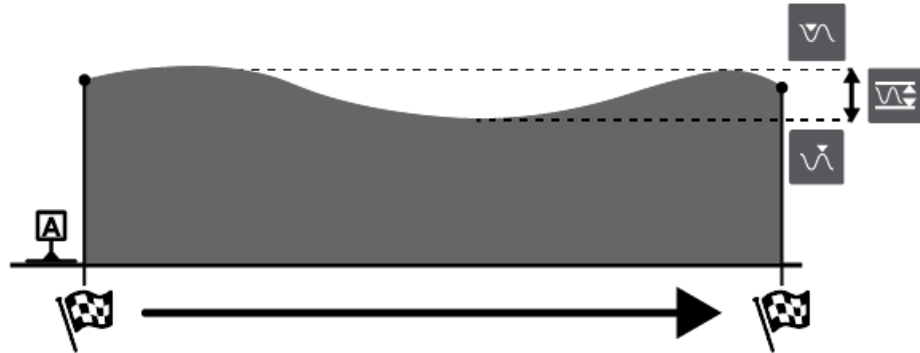

This mode is accessible by pressing the key F_x in $ST1$ or $ST2$ measurement modes.

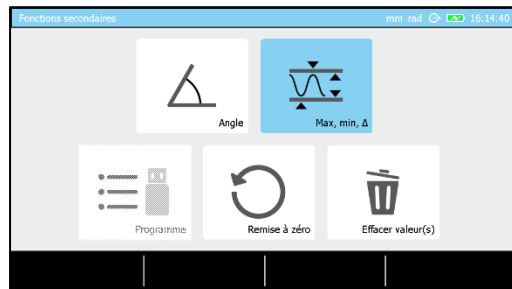

Menu FX from ST1

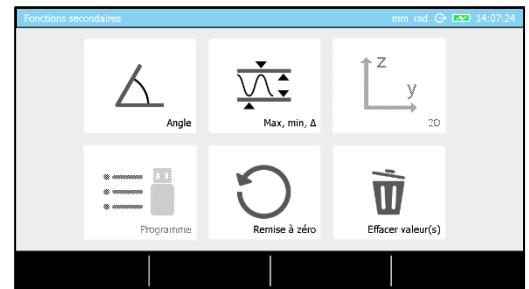

Menu FX from ST2

15.2 Fine adjustment

The fine adjustment device is used to precisely adjust a height. A manual gauge without fine adjustment device can be retrofitted with such option using a special kit.



For questions please contact your local representative.

15.3 Measurement principle (MH+M)

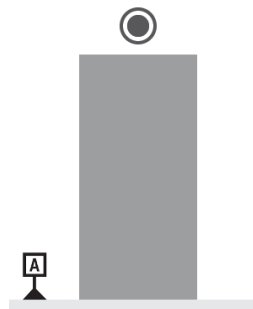
1. Once the measurement mode is activated, position the probe above the surface to be measured.



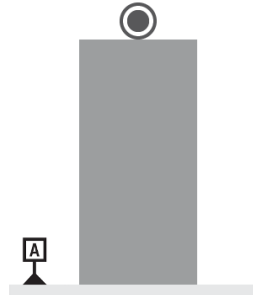

2. Press the key \downarrow or \uparrow that corresponds to the desired measurement direction. The probe will move in the chosen direction in order to establish contact with the workpiece to be measured.

 If *Min*, *Max*, Δ  mode has been activated from *ST1*  mode, one of the two keys will be disabled (the one that does not correspond to the probing direction of the active reference).

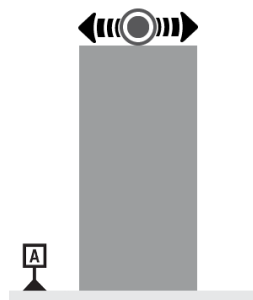

3. Once the pressure on the probe is sufficient to start the measurement, the software will ask you to move the workpiece back and forth, so that the probe is displaced along the whole measurement zone.



4. Validate and finish the measurement using the key .

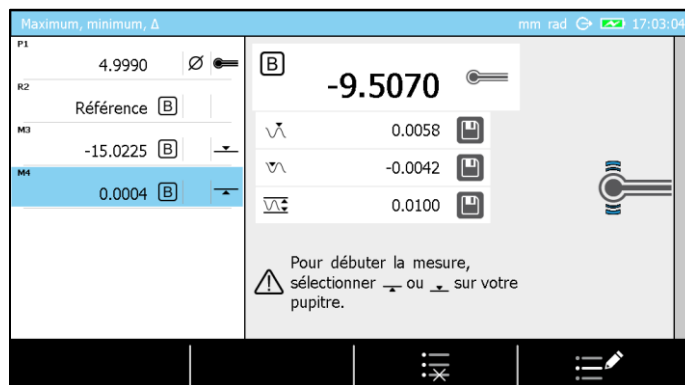

5. Save one or several results in the measurement program/list by clicking on . For example, below the delta value.



6. Press \downarrow or \uparrow again in order to start a new measurement process, press F_x to go back to ST1 mode (respectively ST2) or Home to go back to the main page.

15.4 Measurement principle (MH)

1. Once the measurement mode is activated, position the probe above the surface to be measured.

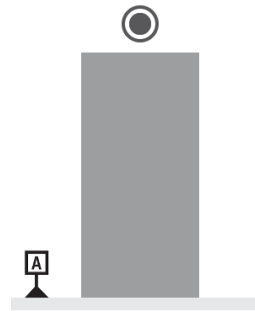

2. Move the probe, so that it establishes contact with the surface of the workpiece to be measured. At that moment, you can decide to use the locking ring (for further details, see this [chapter](#)). It allows you to get the probe positioned at a predefined height in order to carry out your measurement (also using the fine adjustment system). Make sure that the colour of the strain gauge (on the right side of the screen) will stay green.

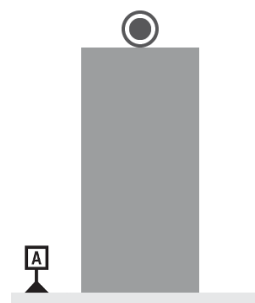

3. Move the workpiece to be measured back and forth, so that the probe is displaced along the whole measurement zone.

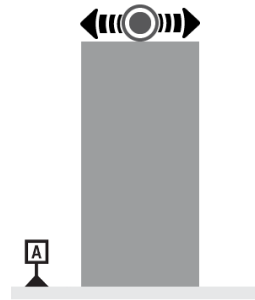



4. Validate and finish the measurement using the key ✓.



5. Save one or several results in the measurement program/list by clicking on . For example, the delta value below has been stored in the measurement memory.



6. You can restart a measurement by establishing contact between the surface and the probe, pressing  to go back to ST1 mode (respectively ST2) or  to go back to the main page.

15.5 Graph

In some cases, you might need to physically locate the maximum (respectively minimum) position of the measured surface. During the measurement, a bar graph or galvanometer is displayed to allow real-time visualization of the probe position.

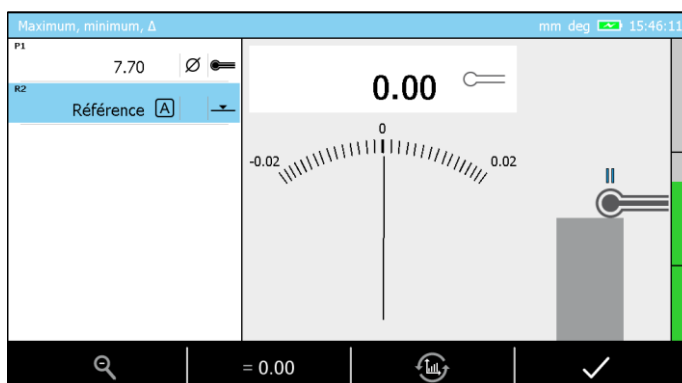
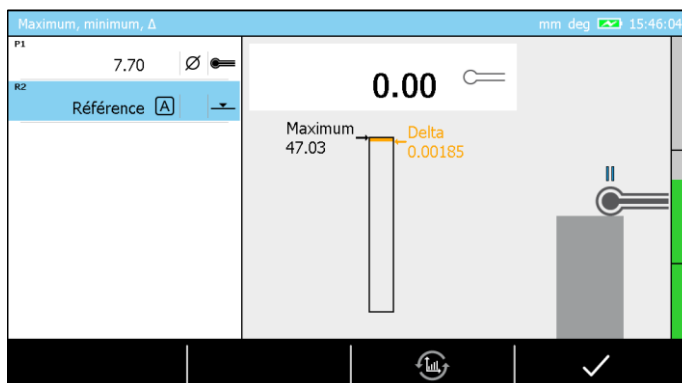

16 ANGLE MEASUREMENT

16.1 Introduction

This mode allows you to measure an angle very easily and in only a few steps. It requires the use of a standard in order to be able to determine the distance X below (the use of an intermediate piece between the standard and the instrument is often required).

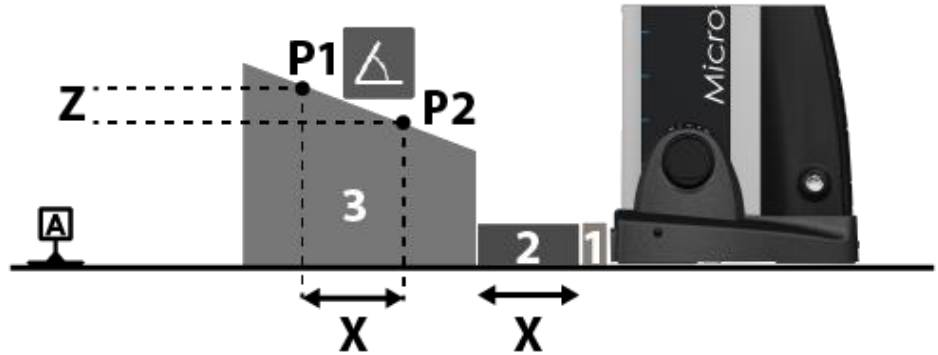

This mode is accessible by pressing the key F_x in $ST1$ or $ST2$ measurement modes.

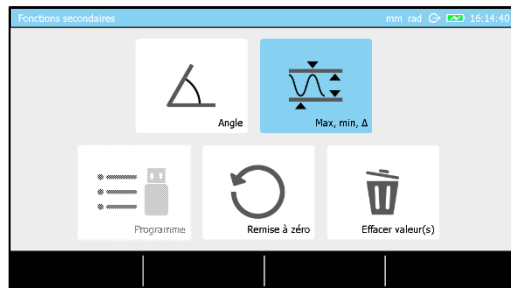

Menu FX from ST1



Menu FX from ST2

Additionally, this mode can also be used to determine the internal or external angle of a cone. Of course, it is the responsibility of the user to define the way of fixing the cone to allow an optimal measurement.

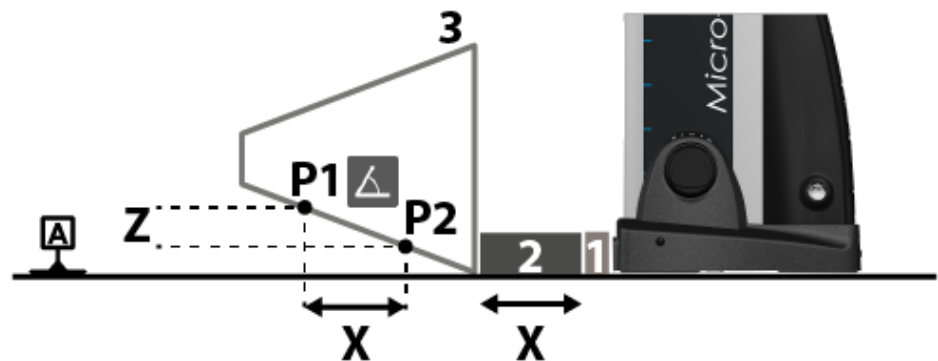

16.2 Measurement principle (MH+M)

1. Once the measurement mode is activated, position the probe above the surface to be measured. You will have to capture the "upper" point of the measurement.





2. Press the key \downarrow . The probe will establish contact with the workpiece to be measured.



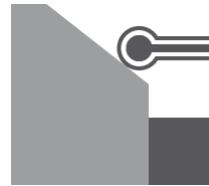

- Place a gauge block (+ intermediate piece) between the workpiece to be measured and the instrument. Measure the second point by pressing . You will capture the “lower” point of the measurement.



- At this step of the procedure, ΔZ (or Z) has been calculated (for further details, see this [chapter](#)). It is now necessary to define ΔX (or X), which corresponds to the size of the standard used. There are two possibilities for the user to do so:

- Enter the gauge block’s value manually by clicking on . Once the value has been entered and validated, it is necessary to finalise the process ignoring the last steps by pressing  (see step No. 6).
- Continue the procedure and measure the standard by capturing point No. 3.

 As the standard has been turned by 90° in order to be measured, the software uses an option mentioning the Z-coordinate: . However, this is still the distance ΔX described [here](#).

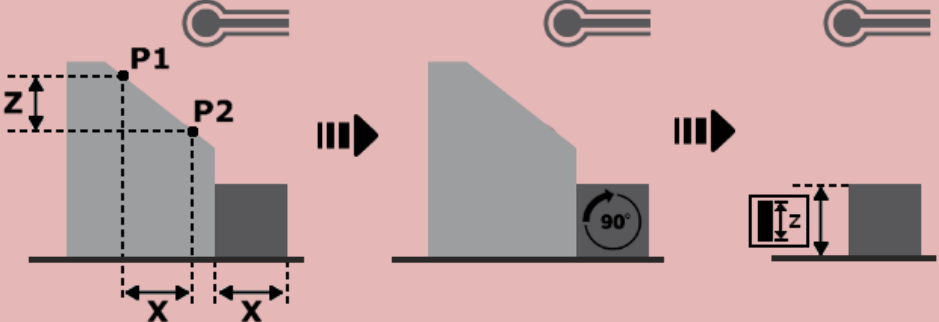





- Now determine the size of the standard by measuring the last point of the process.



6. The measurement results are displayed on the screen. The angle value is automatically saved in the measurement programme. The values of the secondary results can also be stored in the memory by clicking on .



7. It is possible to restart the process by measuring the first point defining another angle by means of , press  to go back to ST1 mode (or ST2) or  to go back to the main page.

16.3 Measurement principle (MH)

1. Once the measurement mode is activated, position the probe above the surface to be measured.





2. Move the probe, so that it establishes contact with the surface of the workpiece to be measured.

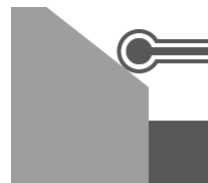

3. Place a gauge block (+ intermediate piece) between the workpiece to be measured and the instrument. Measure the second point.



4. At this step of the procedure, ΔZ (or Z) has been calculated (for further details, see this [chapter](#)). It is now necessary to define ΔX (or X), which corresponds to the size of the standard used. There are two possibilities for the user to do so:

→ Enter the gauge block's value manually by clicking on . Once the value has been entered and validated, it is necessary to finalise the process ignoring the last steps by pressing  (see step No. 6).

→ Continue the procedure and measure the standard by capturing point No. 3.

As the standard has been turned by 90° in order to be measured, the software uses an option mentioning the Z-coordinate: . However, this is still the distance ΔX described [here](#).



5. Now determine the size of the standard by measuring the last point of the process.



6. The measurement results are displayed on the screen. The angle value is automatically saved in the measurement programme. The values of the secondary results can also be stored in the memory by clicking on .

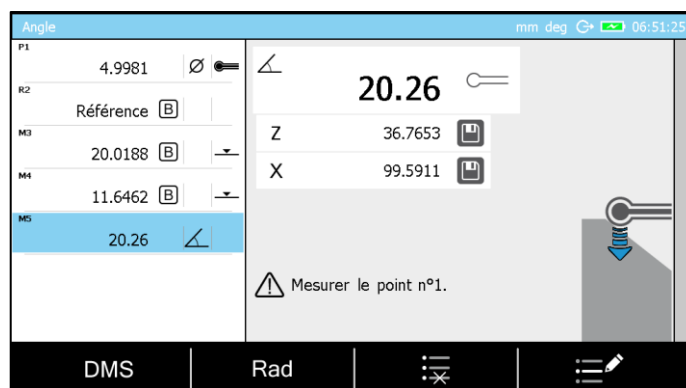

7. It is possible to restart the process by measuring the first point defining another angle, press to go back to ST1 mode (respectively ST2) or to go back to the main page.

16.4 Cone angle measurement principle

The steps of the procedure to measure the internal or external angle of a cone are almost identical to those detailed previously in the chapter about flat surfaces. The only difference lies in the nature of the points measured on or in the cone. Indeed, instead of measuring points on a flat surface, in this case the heights will be measured as culmination points.

17 CALCULATOR

17.1 Generality

The calculator is a very common object and still indispensable for many different and complex measurements. As it is important to be able to work with the measured values without the need to save them on a device or to write them down on paper, a *Calculator* mode has been integrated into the MICRO-HITE or MICRO-HITE+M for more ease of use during the measurement process.



This mode is accessible from the main menu by activating the key  at any moment.



17.2 Concept

The concept of this mode is based on the fact that the user has the possibility either to use it as a standard feature, meaning that the user can manually enter the values that will be used during a calculation or also re-use one or several results of previous measurements (blocks of list).

The mode is presented in the form of a software page split into two distinct parts defined by their function. The zone on the left defines the measurements list. The right zone allows you to enter values and a measurement function.

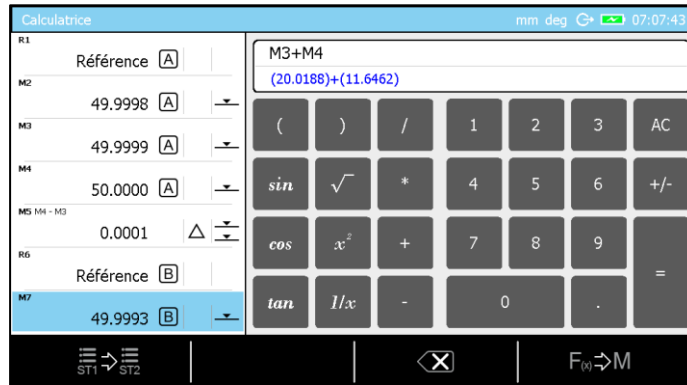

17.3 Use of the measurement blocks

The advantage of this integrated calculator is that the results of previous measurements can be reused for calculation of more complex functions that cannot be defined directly via the control panel.

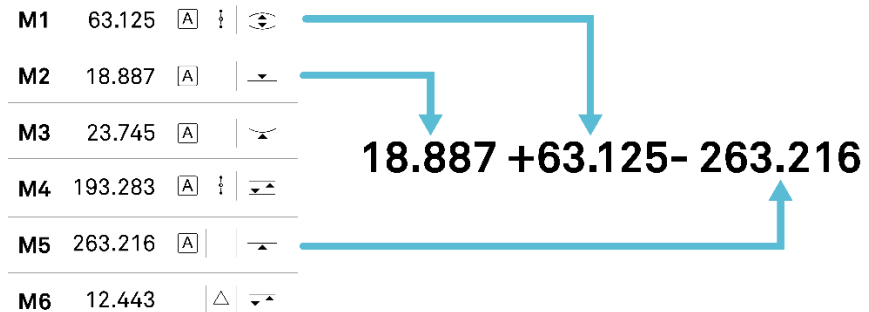

It is important to know in which way the measurement results can be taken into account in the calculation function. You simply have to

- quickly double-click on the measurement block and the value will automatically be copied in the bar dedicated to writing the calculation function.

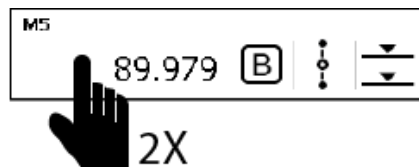

- Move the selection (blue bar) using the keys and , and then validate your choice using .

17.4 Changing measurements list

The two measurements' lists of ST1 and ST2 modes are independent from each other. By default, it is the memory of the last mode that has been activated that will automatically be displayed when entering the Calculator mode.

However, it is possible to go from one memory to the other by clicking on the context-based action key or .

At each change of measurement list, the function defined in the calculator is automatically erased.













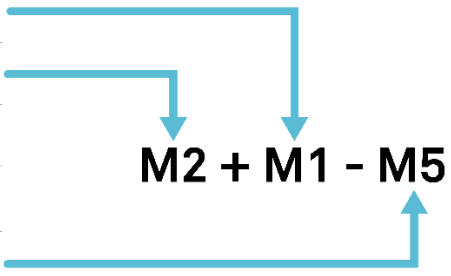

17.5 Customised calculation function



The display of the Calculator mode is defined by two lines:

M3+M4
(20.0188)+(11.6462)

The first line corresponds to the function chosen by the user but only includes the labels of the selected blocks. The second line corresponds to the same function but shows the measurement values of the selected blocks.

It is possible to create a customised function block saved it into the measurement list by clicking on the context-based action key  (e.g. in our example, the calculation block created will include the function M3+M4).

M1	63.125				
M2	18.887				
M3	23.745				
M4	193.283				
M5	263.216				
M6	12.443				

 It is possible to recall a customised function saved in a measurement block by selecting the measurement block and pressing on the context-based action key .

18 PERPENDICULARITY & STRAIGHTNESS MEASUREMENT

18.1 Generality

Apart from the standard measurement $ST1$, $ST2$, angle measurement and parallelism measurement modes, the MICRO-HITE and MICRO-HITE+M have also been especially designed to allow the user to detect form and orientation errors. In other words, they can also be used to determine perpendicularity and straightness deviations.

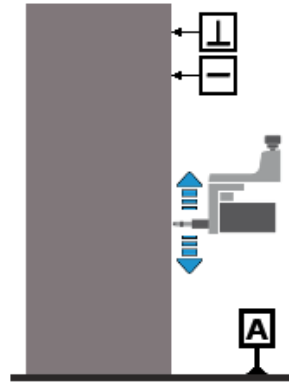

This mode is accessible from the main menu by activating the key at any moment.



There are several types of accessories that, together with the MICRO-HITE or MICRO-HITE+M, allow this determination. Below several possible configurations (non-exhaustive list):

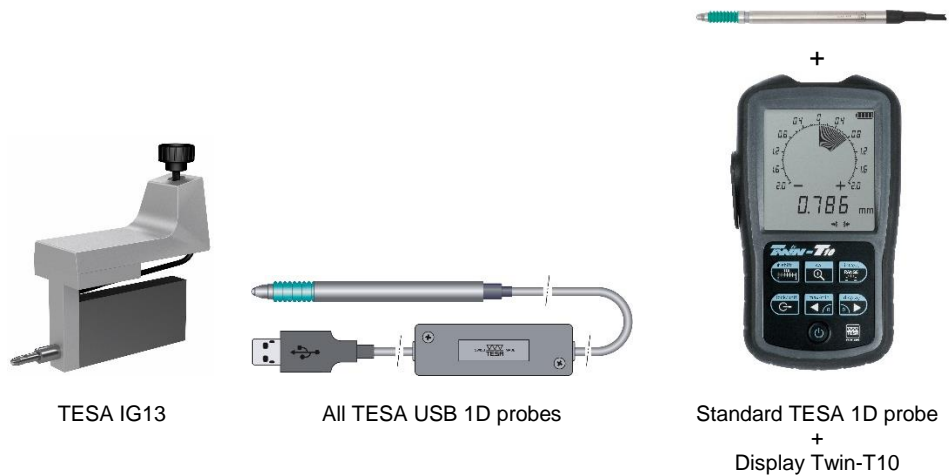

Except for a joint use with the IG13, any other configuration cannot claim to reach other specifications than the ones announced as a mechanical frontal perpendicularity error since the values of the accessories are not compensated. For further information, please contact your local reseller.

The perpendicularity mode of the MICRO-HITE or MICRO-HITE+M are only accessible using a IG13 or any other TESA USB 1D probe.

18.2 Mounting an IG13

The IG13 probe is an optional accessory that enables measurement of all geometric errors defined [here](#). This probe is composed of different elements:

No.	Description
1	Probe head
2	Fixing support
3	Tightening knob
4	Probe
5	Connector
6	Mounting shaft

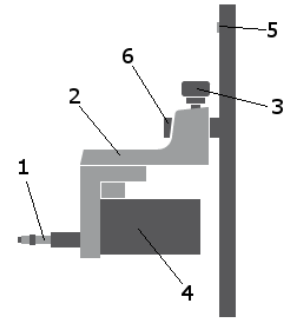

The IG13 must always be used with its fixing system (2), which has to be mounted on the mounting shaft (6). The cable of the probe has to be connected to the plug (5).

1. Before starting to remove the probe and its support on a MICRO-HITE, it is highly recommended to use the locking ring in order to avoid that the measuring carriage will be displaced upwards by the internal counterweight of the instrument.



2. Block the measuring carriage.



3. Remove the probe and its support from the mounting pin.



4. Mount the IG13 on its pin.



5. Connect the IG13 to the height gauge.



6. Unblock the locking ring. The IG13 is now ready to be used.



18.3 Mounting a TESA USB probe

When using the MICRO-HITE or MICRO-HITE+M together with a TESA USB probe, it is necessary to use a probe insert holder (TESA reference: 00760222) specifically adapted to the diameter of the accessory.

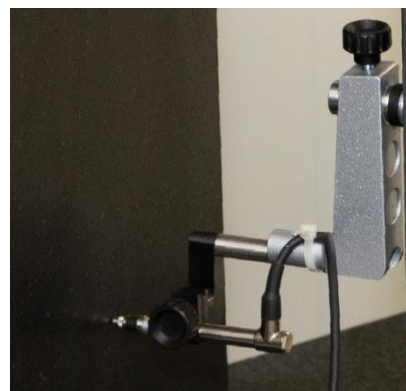
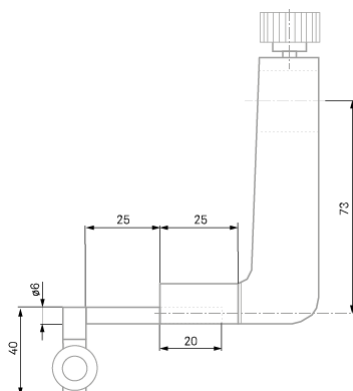

Before starting to remove the probe and its support on a MICRO-HITE, it is highly recommended to use the locking ring in order to avoid that the measuring carriage will be displaced upwards

by the internal counterweight of the instrument. For more details, see the previous chapter on mounting the IG13 probe.

Once the measuring carriage has been blocked, the mounting of the probe-holder system can be performed as described on the photo above.

The end of the probe cable must connect directly to one of the USB inputs, behind the panel. It is not necessary to connect the probe to the first USB port. The three ports can be used without any distinction.

18.4 Adaptor for IG13 connection

If you already had an IG13 before purchasing your MICRO-HITE 2016 or MICRO-HITE+M 2016, it is possible that your accessory cannot be directly connected to the instrument, as the male connector of your IG13 is different from the female connector of your new height gauge.

Therefore, it is necessary to use an adaptor cable (TESA reference: 00760247).



18.5 IG13 positioning

When you are determining perpendicularity and straightness errors, you can measure in the following directions:

- Frontal
- Lateral left
- Lateral right

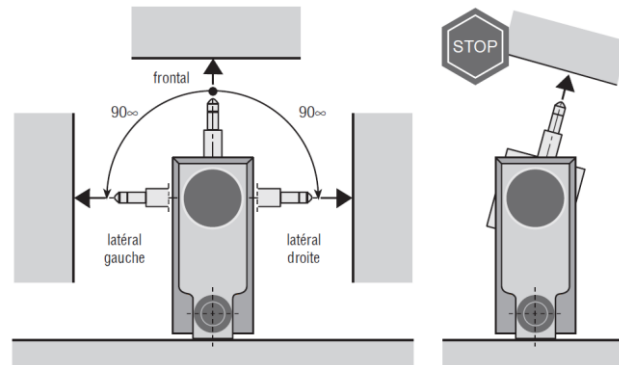

As a result, the instrument includes the automatic compensation of accuracy errors.



The automatic correction of measured values is only active when the IG13 is connected and positioned in one of the three directions determined above. If this is not adhered to or another accessory is used (for example a lever-type dial test indicator), the automatic correction remains inactive and the perpendicularity deviations can exceed the max. values indicated.

18.6 Measurement principle

1. If your height gauge does not detect a connected probe when entering the mode *Perpendicularity*, a message that asks you to do so will appear. To know how to connect your probe, please refer to the previous chapters.

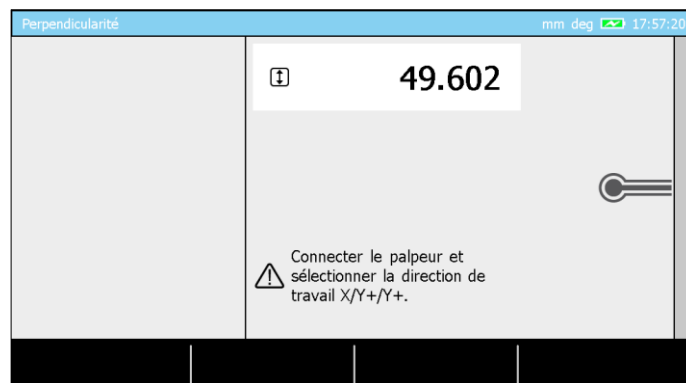

2. Once the accessory is properly connected to the instrument, if you are using an IG13 probe (otherwise please go to step No. 4), the software will ask you to initialize it. Note that each change of direction of the IG13 will require a reinitialisation (for further details, see this [chapter](#)).

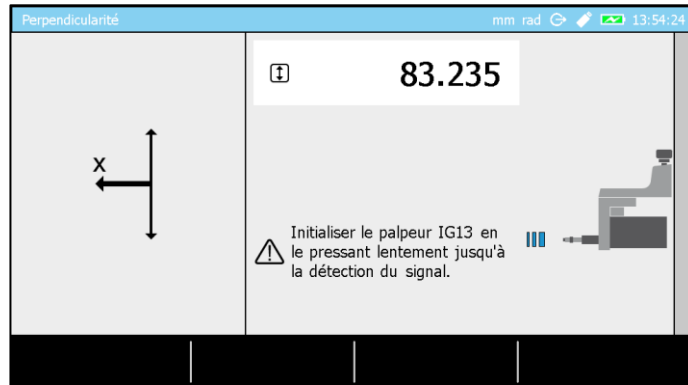

3. Initialise the IG13 by gently pressing its probe until the detection process validates that the probe is correctly recognised.

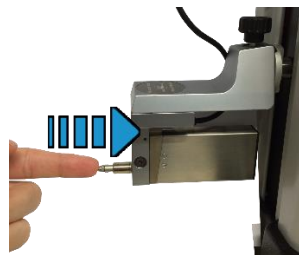

4. Once the IG13 is initialized or the 1D probe detected, the instrument is ready to measure.

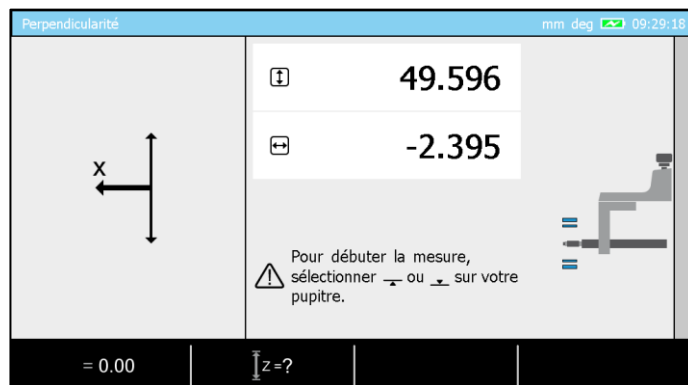

Instrument ready to measure, MH+M, 1D probe

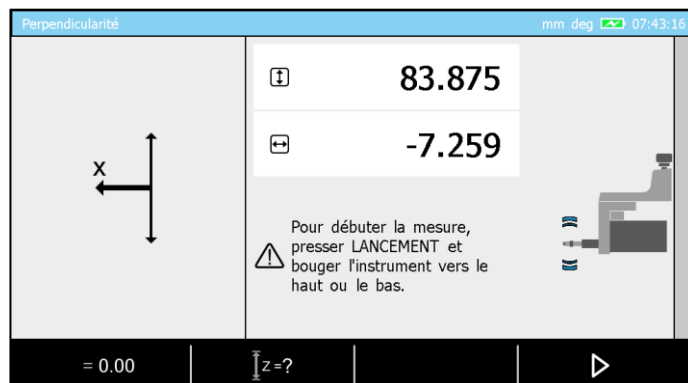



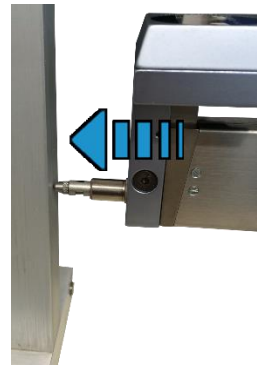

Instrument ready to measure, MH, IG13

For the further process, illustration images comprising of a IG13 will be used. The steps remain however exactly the same if you want to use a 1D probe.

5. Move the workpiece to be measured to the zone of the probe, so that you are able to position it “with pressure” on the surface to be measured. If possible, maintain enough pressure, so that the probe is positioned in the middle of its measuring range.



6. When using a MICRO-HITE, the measurement can only start once the context-based action  has been selected. For a MICRO-HITE+M, simply activating the probing up  or down  options will start the measurement. Note that the rotary control handle can also be used to start the measurement.
7. Once started, the measurement is stopped by a confirmation on the key .
8. The results are automatically displayed on the screen.

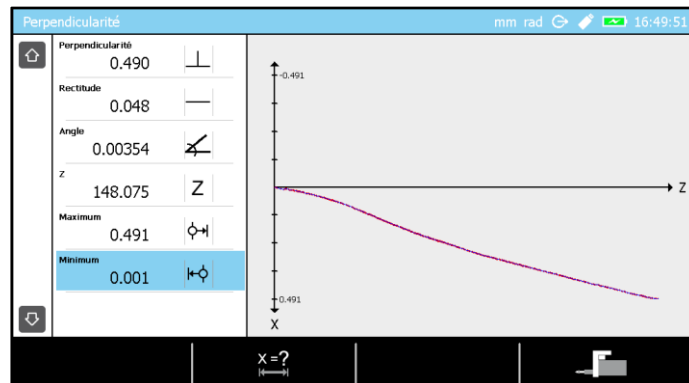

18.7 Displacement speed and direction (MH)

Unlike the motorised MICRO-HITE+M, which has a constant displacement speed during the entire measurement process, the displacement speed of the manual MICRO-HITE directly depends on the user via the handwheel used for displacement.

As all measurement points are stored at a given frequency during the measurement, the displacement speed plays a role in the measurement results. With a high speed, the distance between the measurement points will be bigger and less representative of the measured workpiece. The closer the measured points are, the closer the result will be to reality.

Therefore, if the probe displacement is too quick and exceeds a limit defined in the software (cannot be configured), an informative message will automatically be displayed on the screen. This message only mentions that the speed is too high and that it is important to reduce the speed for good measurements. However, the capturing will not be stopped.

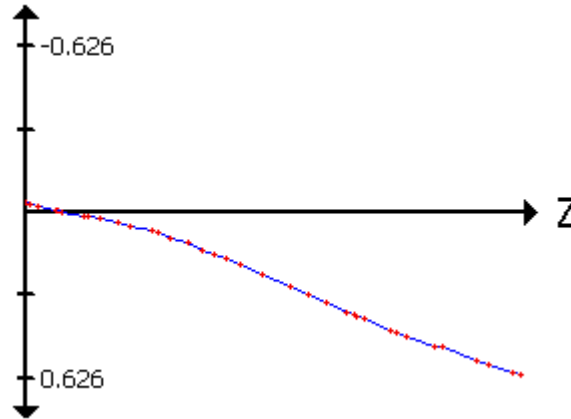

The graph above is an example of the result obtained by using a IG13. The distance between the red points is not the same, which means that the measurement speed had varied. The smaller this distance is, the more precise the (blue) result curve will be.

In addition, it is important not to change abruptly the direction of the probe displacement during the measurement. In other words, if you start the measurement directing the probe upwards (respectively downwards), it is important to maintain this direction during the whole measurement and to avoid going back and forth on the surface. This could have a negative impact on the measurement results.

18.8 Zero setting

Once initialised, the probe sends its position to the measuring range (displayed on the screen). Most of the time, this value is not representative for the result to be obtained.

Once positioned with “pressure” on the workpiece, it is important to set this value to zero - 0.00 before the measurement, in order to have a reference value and to be able to easily read the results once they are displayed on the screen.

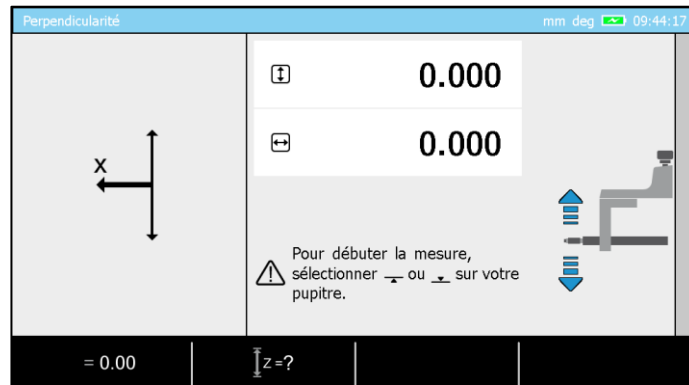

18.9 Measuring range

It is possible to define a range that represents the distance (from the height where the measurement starts) in which the measurement is defined. Once this distance passed, the measurement will automatically stop.

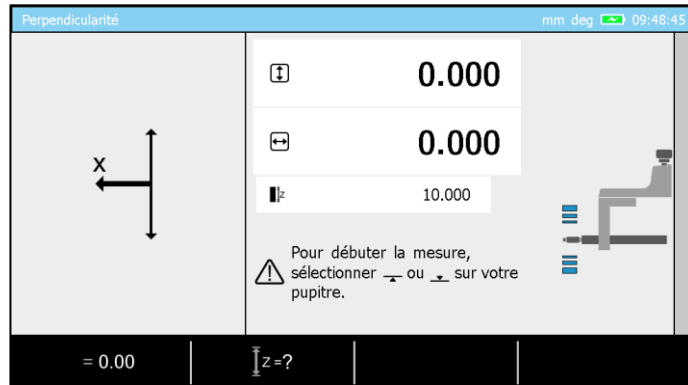

This distance can be set by pressing on the following context-based action: . If a value is inserted, it is displayed on the screen as shown in the above picture (10mm).

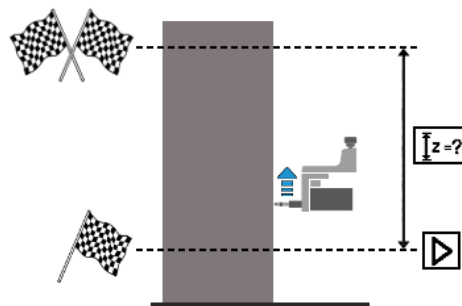

The schema above symbolically represents a measurement upwards with the IG13. Once the measurement automatically stopped, the results will be displayed.

18.10 To pause the measurement

In certain situations, or application cases, it is not possible to continually measure a workpiece in order to define the perpendicularity error for example.

This is why a context-based option is visible at the bottom of the screen when the measurement is started. This option allows you to pause the measurement in order to be able to displace the probe from one measurement zone to the other without influencing the results by capturing points you do not want to measure.

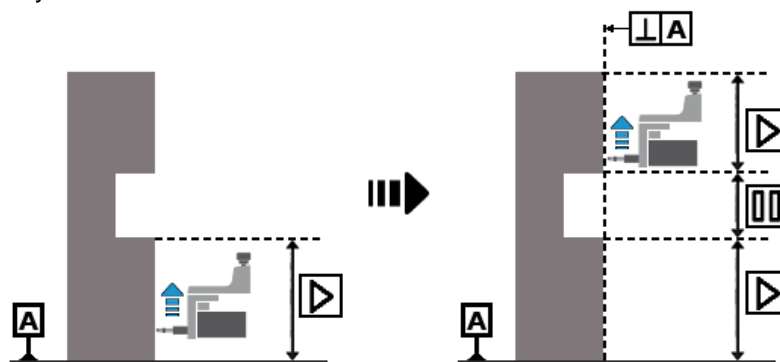

The schema above represents a situation in which the option is necessary. While the measurement is direct in the first zone, the option is required in order to allow the displacement of the IG13 on the upper part of the workpiece without changing the measurement results.

18.11 Measurement results

Once the measurement has been confirmed, several characteristics are automatically been displayed on the screen.

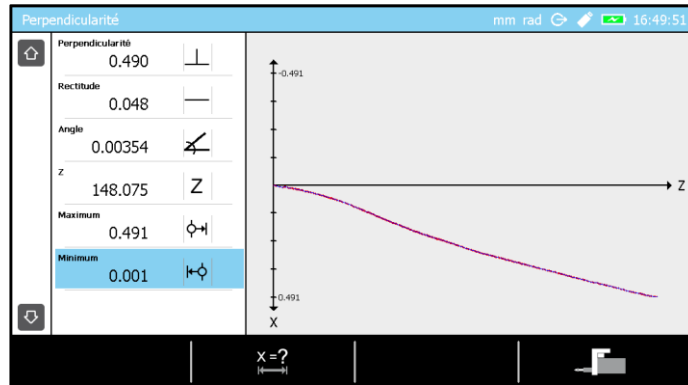

- Perpendicularity
- Straightness
- Angle
- The Z height representing the measurement range
- Maximum positive value
- Maximum negative value

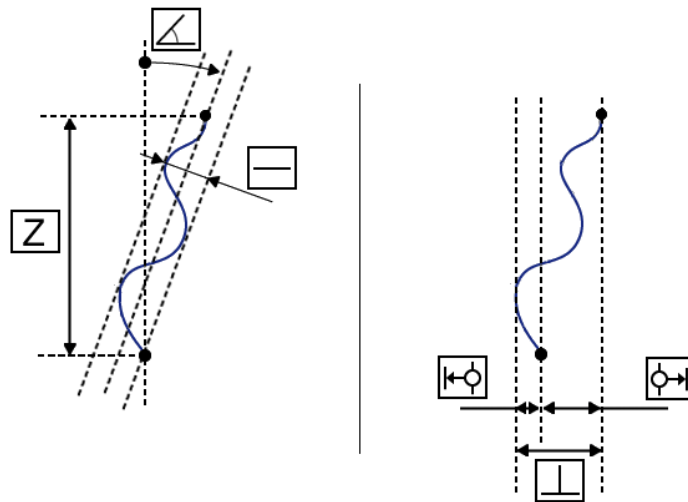

19 2D MODE

19.1 Introduction

The MICRO-HITE or MICRO-HITE+M is a height gauge that is basically used to measure only when being positioned on a reference plane (granite table) (3) or any other similar surface. The measures are then performed in one coordinate direction only (2), orientated perpendicularly to the reference plane (1).

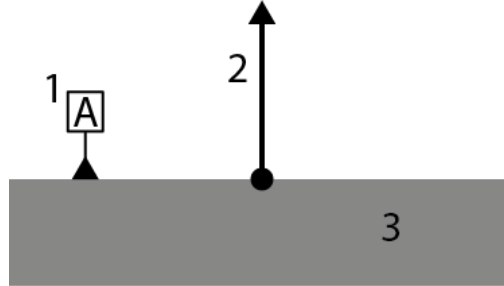

Indeed, it is not possible to proceed to measurement of elements directly in two coordinates without going through measuring steps split by a piece rotation in the directions of the wished coordinates.

The 2D mode is directly accessible from the F_x button of the keyboard when being in ST2 mode.



 The 2D mode is enabled only if a reference has been previously defined in ST2 mode. If you cannot select the 2D mode, return in ST2 mode pressing F_x , then define the reference and come back to the menu with F_x again.

19.2 Concept

The use of the 2D mode implies to go through two steps that will allow then to start the analysis from the received results called “raw data”.

- **Step 1:** Y coordinates measurement
- **Step 2:** Z coordinates measurement

The opposite is also valid as the user has the possibility to switch from one axis to the other.

 Even if it is possible to change the reference axis in the middle of the raw data measurement, it is preferable to measure all coordinates of the same axis straight and then change the axis for the second batch of measurement in the other axis.

The first step consists in measuring all Z (or Y) coordinates of axis and bore centres.

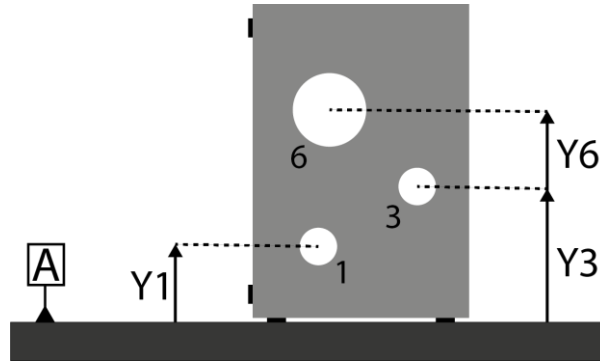

Then the piece is rotated by a wished angle (in our example the part is rotated by 90°) in order to position the part good enough to measure the second Y (or Z) coordinates.

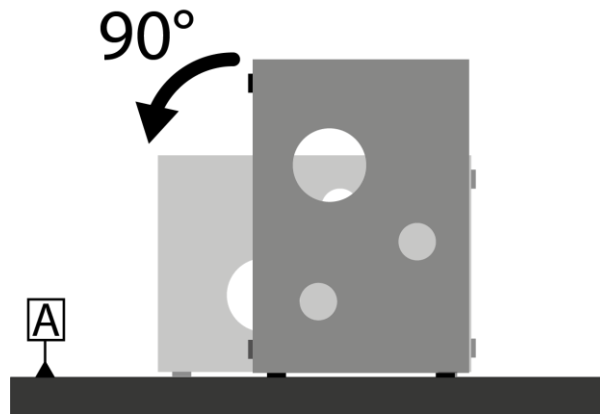

Once rotated, all same elements have to be measured again in a similar sequence as the one followed previously for Y coordinates measurement.

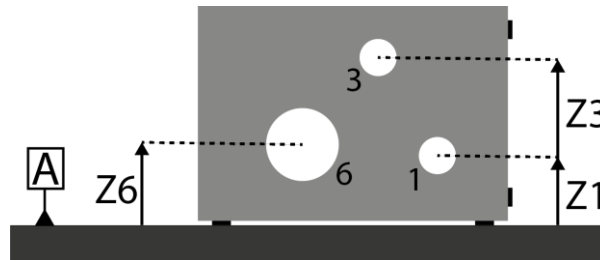

(Y;Z) coordinates of each element is called "raw data". It is from these values that calculation will be performed. The analysis is the last step of the process.

19.3 Two measurement possibilities

For each axis or bore measurement, the user has the possibility to find the element centre height following two processes:

Without looking for the culmination point

On MICRO-HITE+M this way of doing corresponds to the  button of the panel keyboard.

This process is the mean to determine quickly the centre coordinate without getting the diameter of the measured element. Indeed, the below graph shows a H coordinate research through  measuring option. The probe is probably not centred in the bore. Therefore the

software will determine the H coordinate using the P3 point but the distance between P1 and P2 does not correspond to the diameter of the bore.

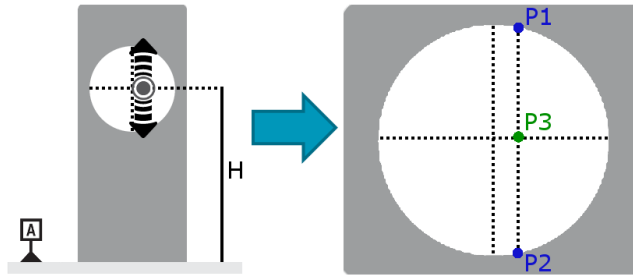

The software will then display only the measured coordinate in the corresponding block (Z in our case).



Looking for the culmination point

On MICRO-HITE+M, this way of doing corresponds to and button of the panel keyboard.

On the contrary, using one of the methods for checking the culmination point, P1 and P2 are really the maximum and minimum locations of the bore. This is the reason why, as results, H will be given as P3 coordinate as well as the bore diameter, distance between P1 and P2.

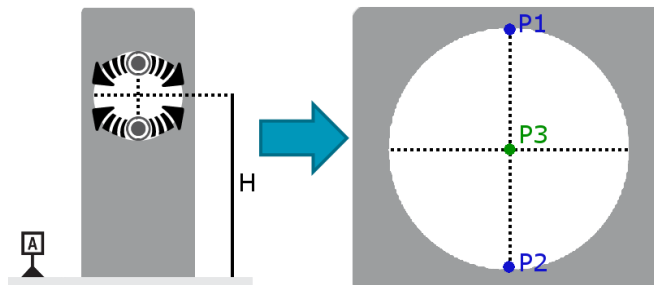

In this case, the software displayed not only the measured coordinate but also the element diameter.

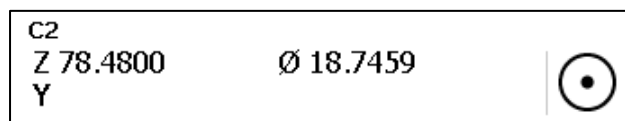

19.4 Application examples

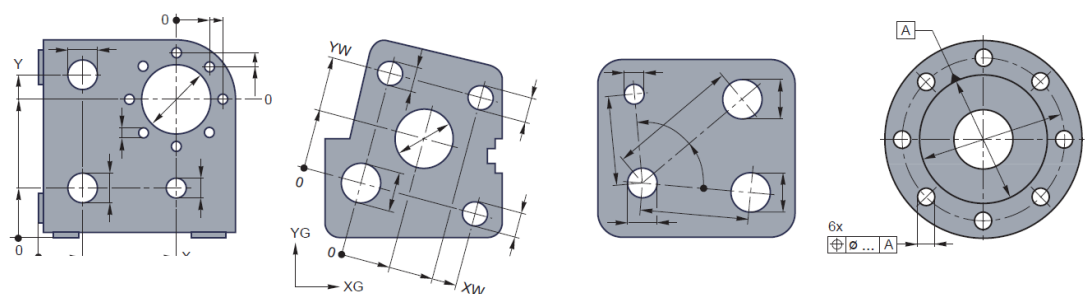

19.5 Step by step example

In this chapter we will show an example in order to clarify the needed steps to determine and get the right raw data. If you want to have more information about how we can analyse the data, please refer to the next chapters.

For this example, we will consider that the angle between the two reference surface of our part is perfect, at 90°.

 **Before starting any measurement in 2D mode, it is important to know the angle between the two supporting surfaces of your part on the granite table. This angle can be, for instance, determined with the help of an IG13 probe. For more information, please contact your local representative.**

1. From main menu, enter in ST2.



2. Calibrate the probe using the masterpiece delivered with the instrument.

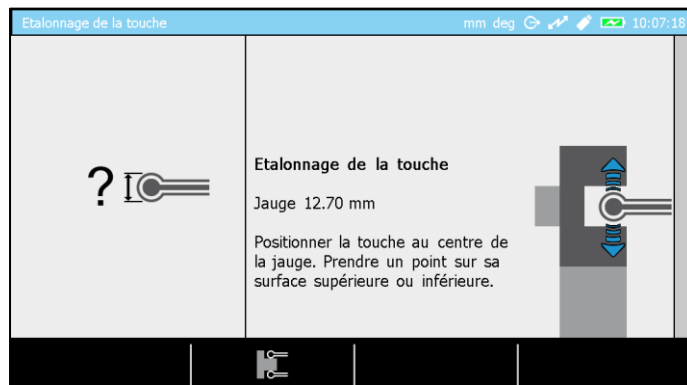

3. Once the probe calibrated you will enter automatically in ST2 mode.

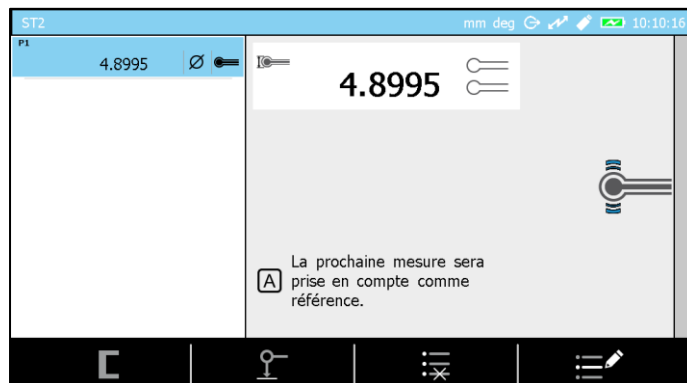

4. Take the reference on the table on which the part to be measured will be placed. Please note that if the reference is not measured, you will not have the possibility to enter the 2D mode.

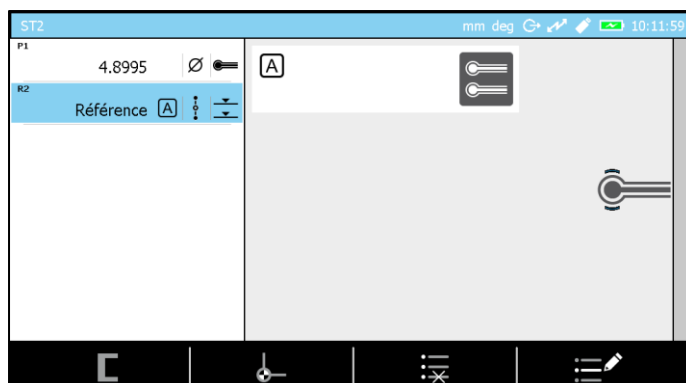

5. Press **F₃** button from panel keyboard.



6. Select 2D mode. The software shows now the page dedicated to raw data measurement.

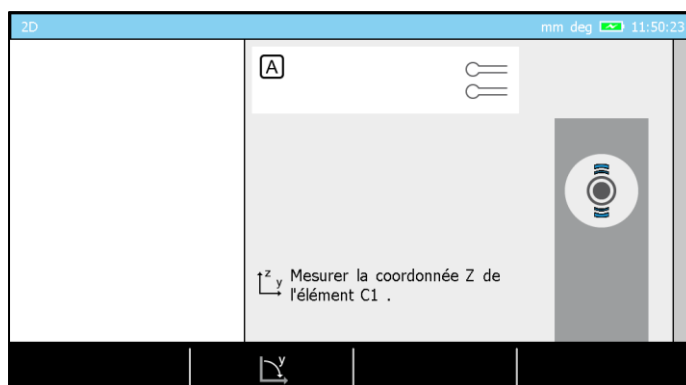

7. Position the piece on the table so that the probe can access all elements you want to be measured.

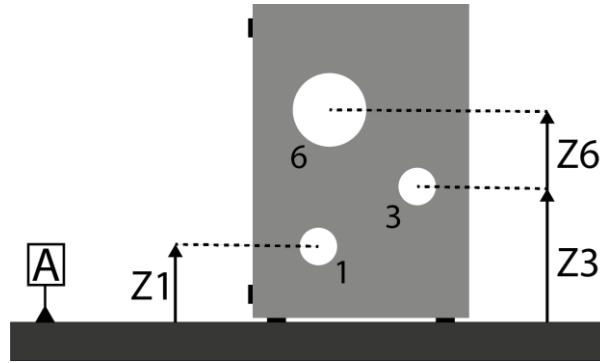

8. Measure each bore following the official processes described before in this document (up/down or with culmination points).



9. Rotate the part in order to position it in an optimal way for the measurement of the second coordinates (in our example it is 90°).

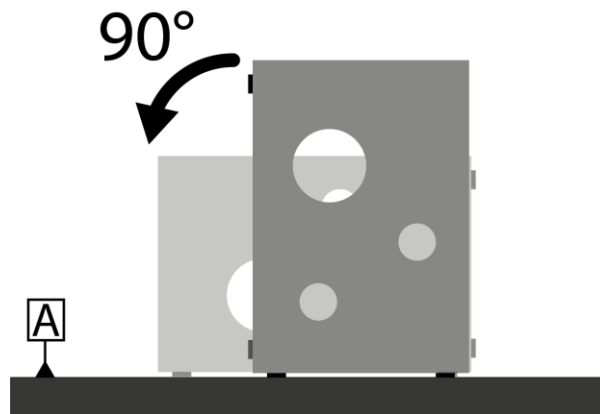

10. Press , insert the rotation angle (90° in our example) and confirm.



11. Start the measurement of the second coordinates in a similar sequence as the one followed to measure Z coordinates.

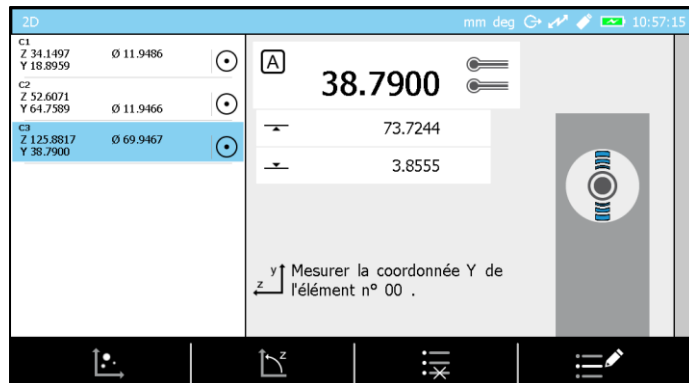

12. Raw data are now measured

It is always possible to continue to add raw data going from a coordinate to another via the and actions.

If raw data measurement process is over, it is possible to go to the values display and analysis page using .

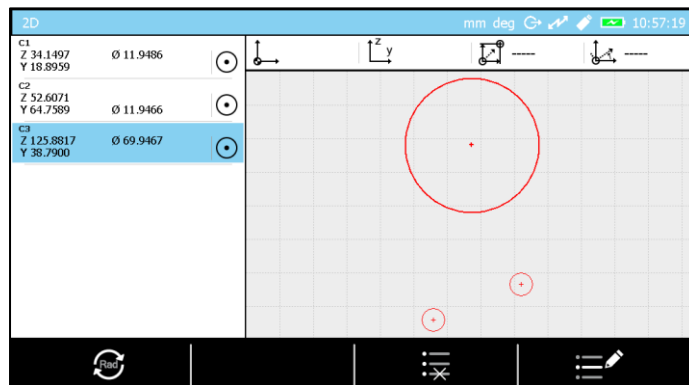

19.6 Results analysis

The software page dedicated to data analysis is split into several zones:

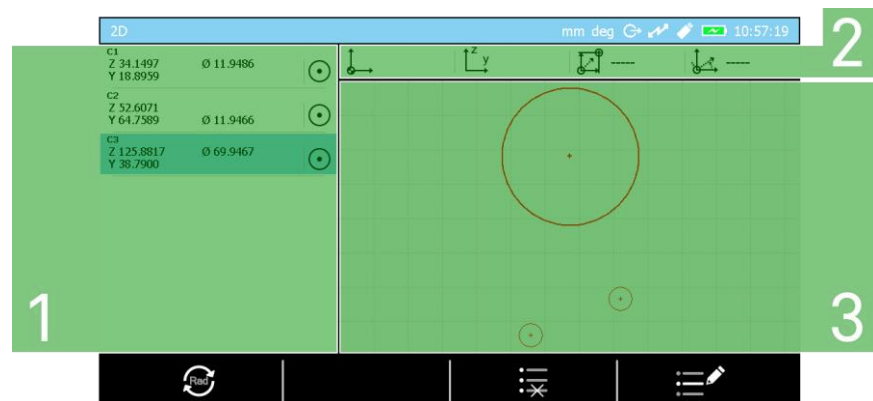

No.	Description
1	Measurements list <ul style="list-style-type: none"> • Raw data blocks • Calculation blocks
2	Current datum <ul style="list-style-type: none"> • Block used as origin • Block used as Y- or Z-axis reference • Origin translation value • Datum rotation value
3	Graph that represents the coordinate system as well as all calculated and measured elements

19.7 To define a datum

Once raw data are known, the first step consists in setting a datum. For this explanation we will continue with our previous example.

1. Select one of the raw data blocks (C1 for instance). For this, you can either click on the wanted block from the touch screen or use the keyboard arrows buttons.

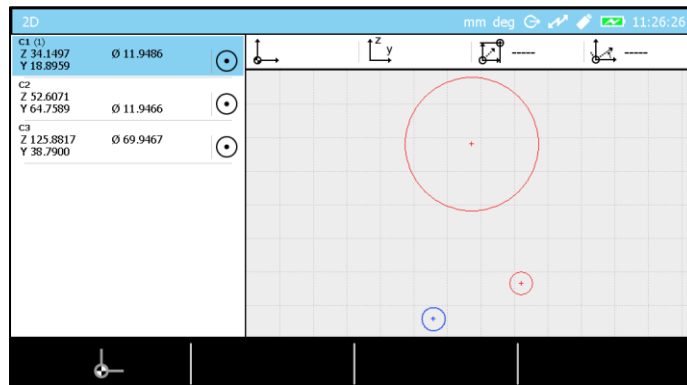

Note that the selected block has a (1) nearby its name and that the corresponding circle has become blue in the graph.



Selecting a bloc (blue rectangle) implies the corresponding element becomes blue in the graph.

The available options (linked to the selected blocks) are displayed in the bottom screen bar. In our example, when a unique point or a circle is being selected, only this option is available. It is the option that allows to set a point or the centre of a circle as reference/origin.

2. Press .

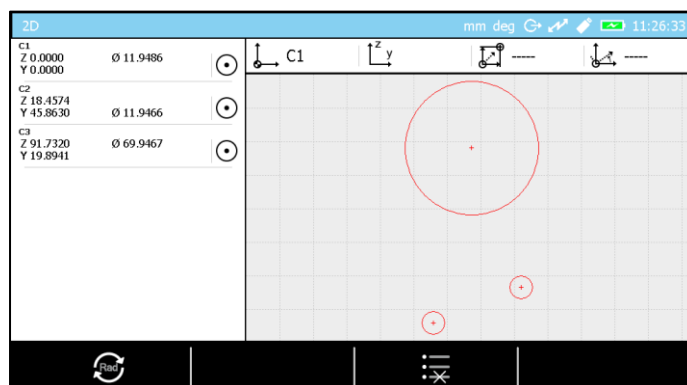

All coordinates have been modified according to the new origin that we can see in the current datum status bar. C1 is now the new origin.

We consider now that we want to define the line going through C1 and C2 as Y axis reference.

3. Select C1 and C2 blocks.

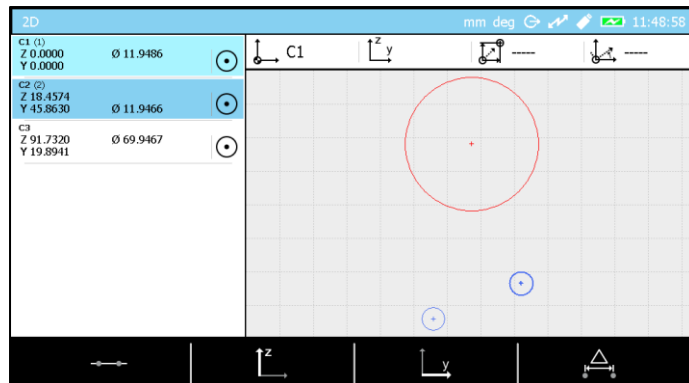

4. Press

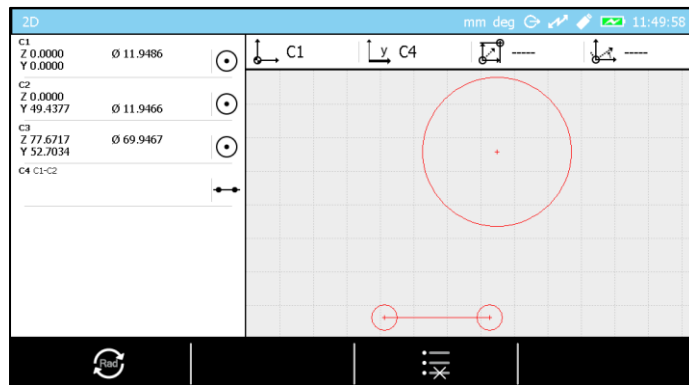

A C4 line is automatically created in the list and set as Y axis reference (visible as well in the current datum status bar).

19.8 Where is the current datum?

If you cannot remember where the current datum is, you can simply look at the graph on the right side of the screen and find where the icon is.

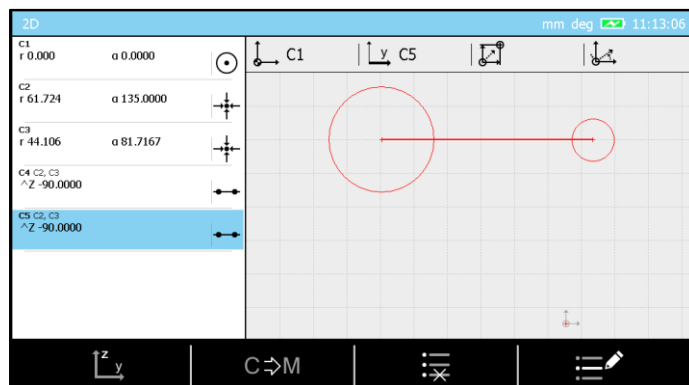

19.9 Change the coordinate system

The 2D mode analysis page allows using two coordinate system types:

- Polar
- Cartesian

You can easily switch from one to the other using the following context-based actions: to switch to polar coordinates and for the Cartesian coordinates.

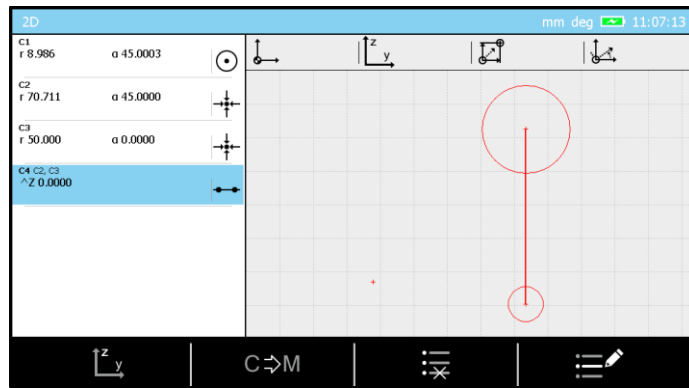

19.10 To define an origin

An origin can be defined when only one block is selected and then using the action. The block can either be a single point or a circle represented by its centre.



19.11 To defined a reference axis

A reference axis can be defined with or actions selecting:

- Two points
- Two circles
- A point and a circle
- A line

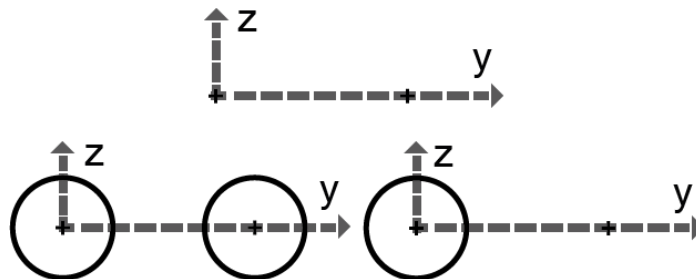

19.12 Midpoint

It is possible to construct a midpoint using action if the following two blocks are selected:

- Two points
- Two circles
- A point and a circle

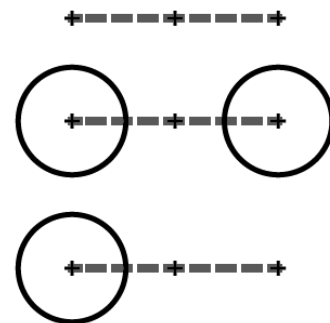

19.13 Intersection of two lines

It is possible to construct an intersection point between two lines by selecting the following context-based action .

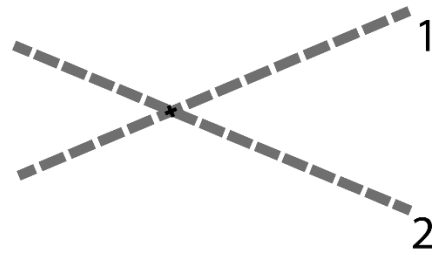

19.14 Line through 2 points

It is possible to construct a perfect line using  action if the following two blocks as selected:

- Two points
- Two circles
- A point and a circle

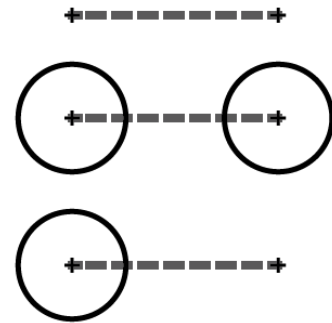

19.15 Bestfit line

A bestfit line is a line being calculated from three blocks (or more) being either points or circles (or a mix of both). This line minimises the D1, D2, D3, D4 et D5 distances (in our below example for instance).

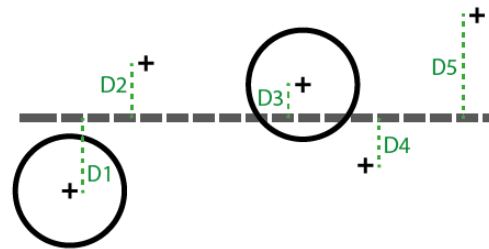

A best fit line can be calculated via the  action.

19.16 Circle through 3 points

It is possible to construct a perfect circle with  action if the following three blocks have been selected:

- Three points
- Three circles
- A combination of three blocks with points and circles

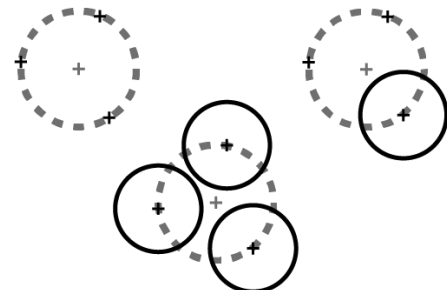

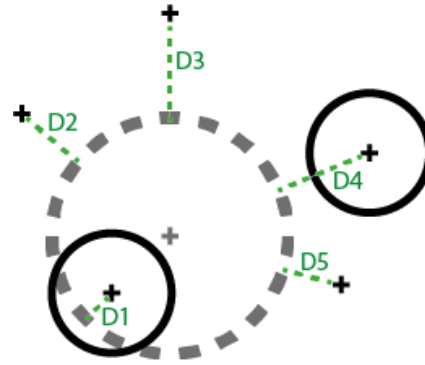

19.17 Bestfit circle

A bestfit circle is a circle calculated from a selection of four blocks (or more). These blocks are either points or circles (or a mix between both). This circle minimises D1, D2, D3, D4 et D5 distances (in our below example for instance).



A bestfit circle can be calculated with  action.

19.18 Distance between 2 points

It is possible to get the distance between two points, two circles (or a mix between them) using the  action or the  keyboard button.

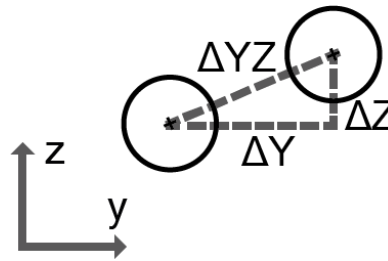

19.19 Angle by 3 points

In order to calculate this angle it is mandatory to have selected:

- Three points
- Three circles
- A combination of three blocks with points and circles

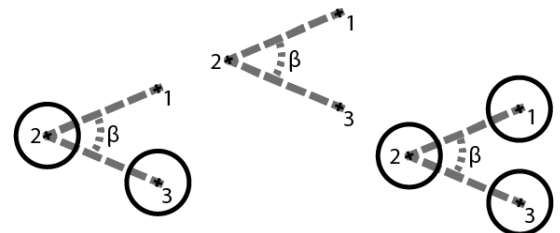

The angle can be calculated with  action.



The selection sequence has an impact on the result.

19.20 Angle between two lines

In order to calculate the angle between two lines it is mandatory to select two blocks representing lines and confirm the action with .



The selection sequence has an impact on the result.

19.21 Angle with axes of the current datum

Sometimes it is important to be able to obtain the angle that a line forms with one of the axes of the current datum. Therefore you can just create the desired line (see these chapters: [line by two points](#), [bestfit line](#)) in the measurement history. The created block will always automatically contain the angle that the line forms with the Z axis.



If you want to get the angle that the line forms with the Y axis when running a program, you just have to exit the 2D mode and create a customised function block containing: 90 ° angle with Z-axis.

19.22 Perpendicular distance

The perpendicular distance between a line and a point/circle can be calculated with option.



19.23 To create a virtual point

It is possible to create a virtual point from the options given in menu.

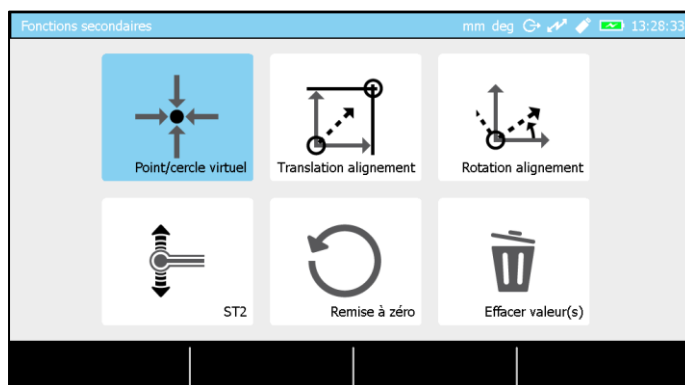

Once entered in this menu and the option selected, the coordinates should be inserted and confirmed in order to create a new block in the measurements list.

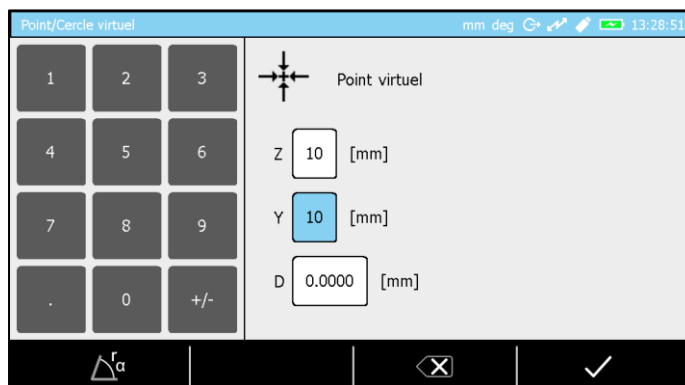

19.24 To create a virtual circle

It is possible to create a virtual circle from the options given in menu.

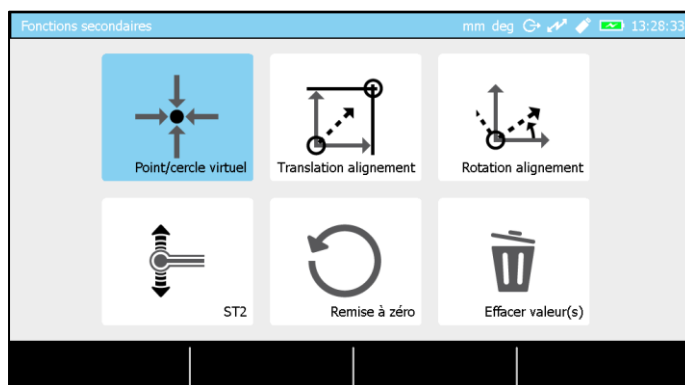

Once entered in the menu and having the option selected, the coordinated of the centre and the diameter of the circle should be inserted and confirmed in order to create a new block in measurements list.

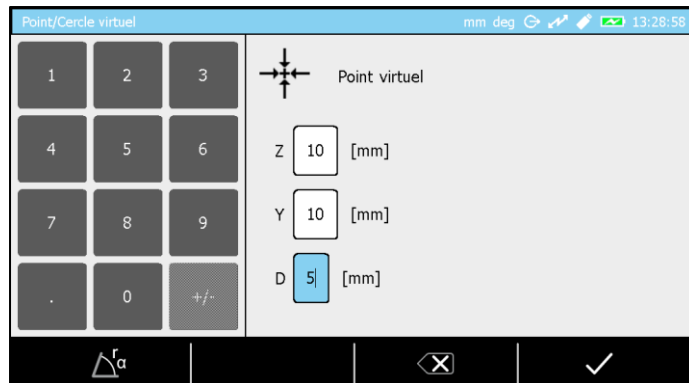

19.25 Origin translation

The coordinates of the current origin can be changed and modified from the options given in **F_x** menu.

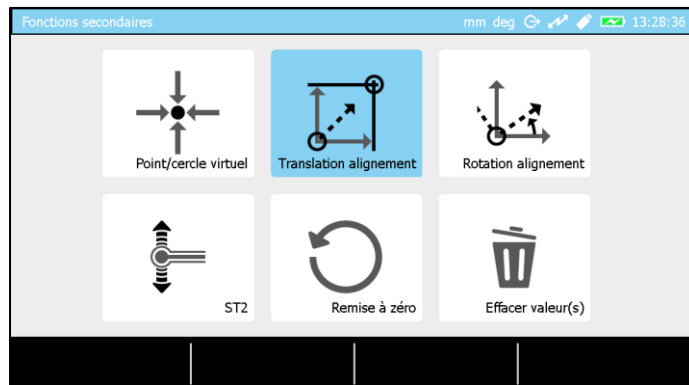

Once entered in the menu and the option selected, the coordinates of the new origin can be inserted and confirmed.

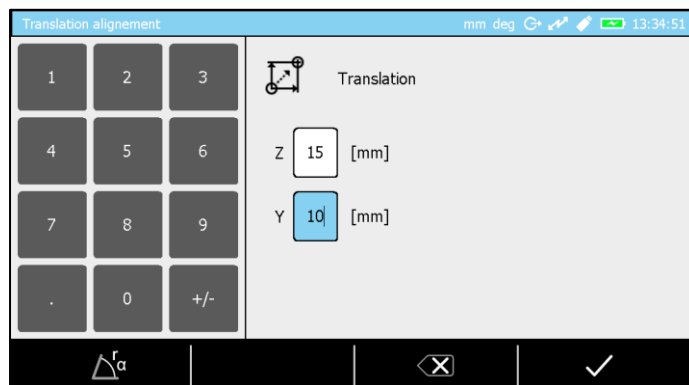

Once confirmed the values are visible at the top of the screen in the current datum status bar.

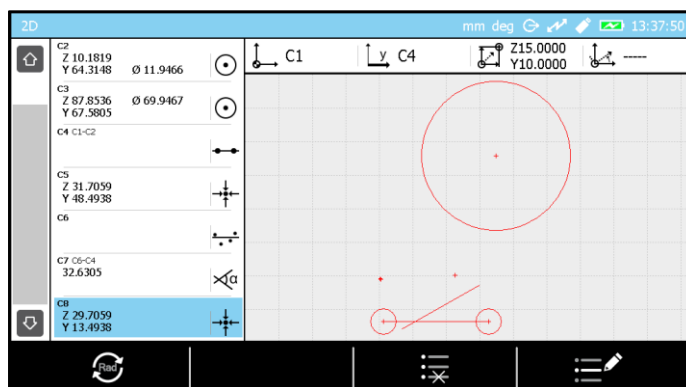

19.26 Datum rotation

The orientation of the current datum can be modified from the options given in **F_x** menu.

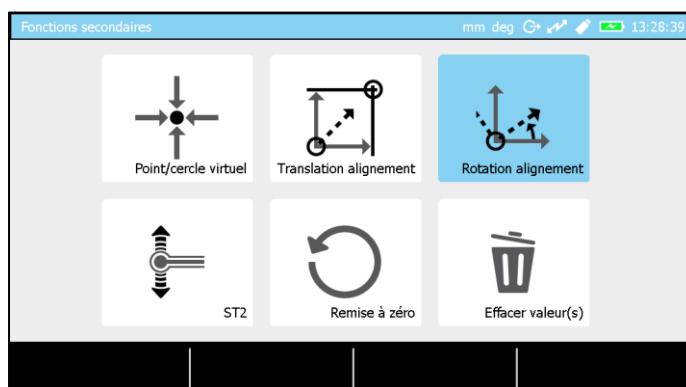

Once entered in the menu and having the option selected, the angle of the rotation can be inserted and validated.

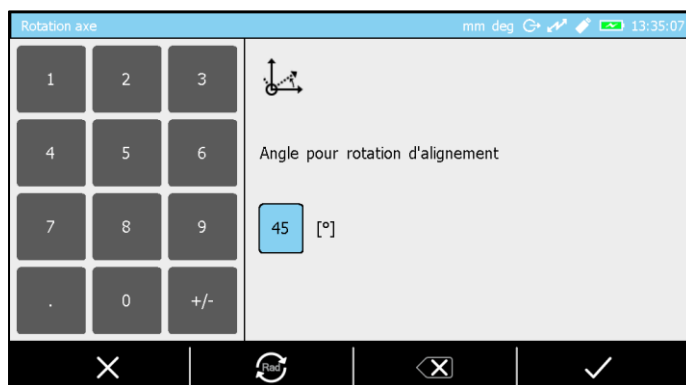

This angle is now visible at the top of the screen, in the current datum status bar.

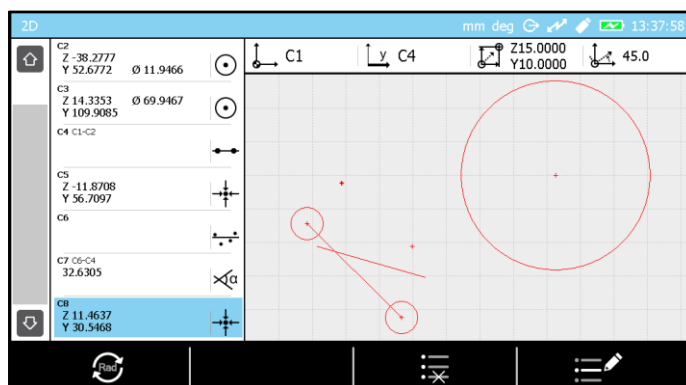

19.27 How to integrate a result from the 2D mode into a measurement program?

As you have seen earlier in this chapter, the 2D mode can exclusively be accessed via the ST2 mode. That means, that the 2D mode is included in the ST2 mode, as well as in the *Angle* or *Min, Max, Delta* mode.

Therefore, in order to be able to re-execute a 2D calculation sequence later on another piece to be measured, one or more results from the 2D mode must be saved in the history of the ST2 mode.

The measurement blocks of the ST2 mode are generally called M1, M2, M3, M4, ... (M for "measure" in English). The measurement blocks of the 2D mode are generally called C1, C2, C3, ... (C for "circle" in English). This is why you will be able to store a 2D result in the ST2 mode memory by pressing the context-based action . A block C of the memory of the 2D mode then becomes an M block in the ST2 mode memory.

Below is an example of a program creation containing results from the 2D mode.

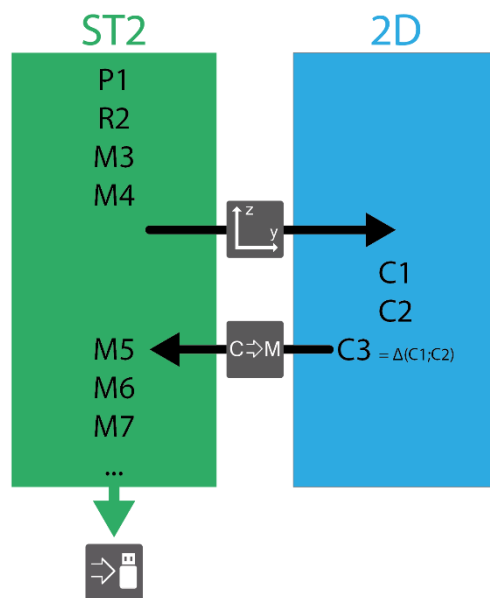

1. Calibrate the probe to enter ST2 mode (P1)
2. Capturing the reference (R2)
3. Measurement of any point (M3)
4. Measurement of any other point (M4)
5. Switching from ST2 mode to 2D mode
6. Measurement of the Z coordinates of two circles
7. Rotate the part by a given angle
8. Measurement of the Y coordinates of the two circles
9. C1 and C2 are raw data ready to be used
10. Calculation of the distance between these two circles (C3)
11. C3 is sent in the memory of ST2 and becomes M5
12. Measurement of any point (M6)
13. Measurement of any other point (M7) and continuation of the program
14. Saving the program on USB key

The screen shots below succinctly describe the previously explained process. We will consider that the basic principles of the ST2 mode (calibration of the probe, ...) and 2D (measurement of raw data, ..) are known.

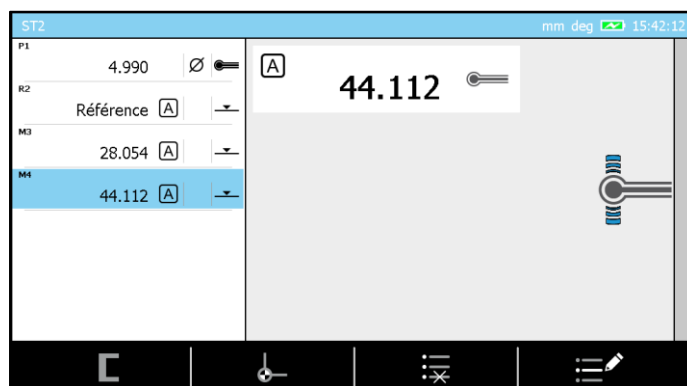

From the ST2 mode where there are already four memory blocks (probe calibration, capturing the reference and any two measurements), switch to the 2D mode via the secondary function menu . Once in the 2D mode measure two circles using the normal procedure explained in this chapter.

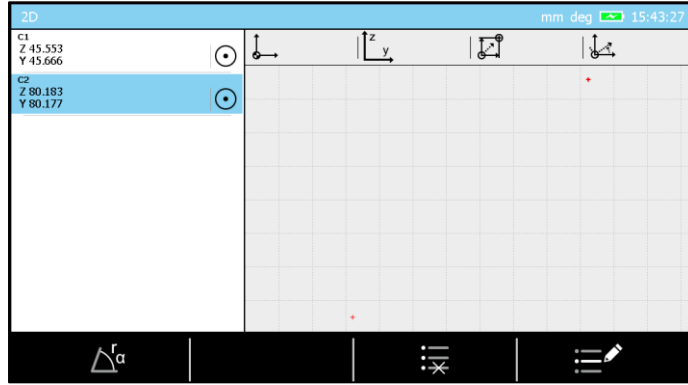

Now that the two circles are measured, calculate the distance between their two centres.

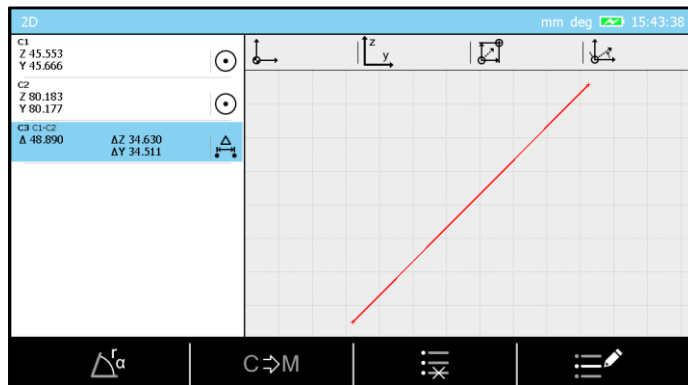

A new C3 block is created in the memory. Now you have to transfer it to the ST2 mode memory by pressing the **C→M** button. At this moment a beep should sound.

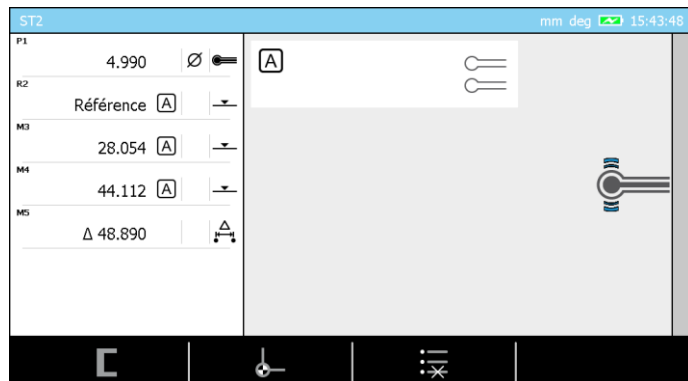

A new M5 block is now created in the ST2 mode memory. This block represents the distance between the two circles measured in the 2D mode. The user can continue to feed ST2 mode memory by continuing the measurements or saving the program.

When the software arrives at the M5 block during the execution of this program, it will automatically enter the 2D mode and ask the operator to measure the two circles he needs to set the M5 distance.

20 ZZ MODE

20.1 Generality

ZZ mode (or continued display) is often selected when a measurement requires a lower probing force than that proposed by the column in a standard configuration. This is the reason why this mode is mainly used with an external measurement unit (for example a lever-type indicator).

This mode is accessible from the main menu by pressing the  key at any moment.

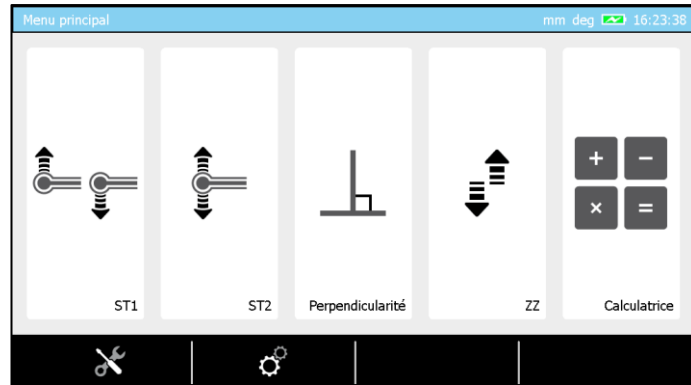

20.2 Operating principle

This mode is called continued display because the value displayed on the screen is updated at any time according to the position of the carriage for displacement on the glass scale of the instrument.

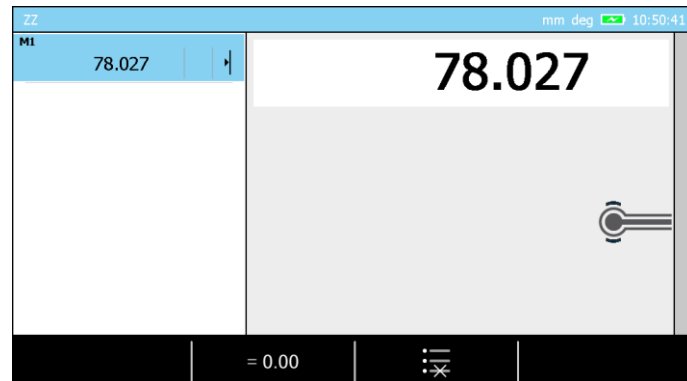

When using this mode, it is firstly important to lock the double carriage by tightening the screw on the front of the instrument.

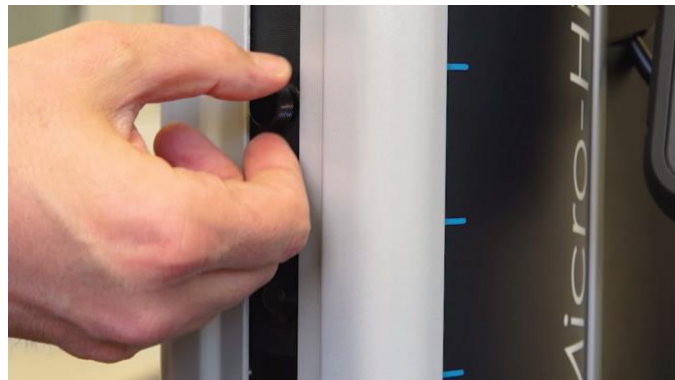



The continued display can be reset at any time by pressing the context-based action .

It is also possible to save an instant value in the measurement list by pressing the  button on the control panel.



It is not possible to save a program from the ZZ mode. It is not possible to use the calculator starting from the ZZ mode values.





You can quickly calculate differences or averages by pressing the  or  keys on the control panel.

21 DATA MANAGEMENT

21.1 Generality

Your control panel offers the possibility to manage measurement data by sending it to several different peripherals. Each one of these processes is independent from the others. Therefore, each one of the possibilities can be enabled and used at the same time as the others. All combinations are possible. You could for example store your data on a USB key and, at the same time as sending results to a computer via the TLC connector.

 **It is not possible to connect the control panel directly to the local network of a company. The only possible solution is to send data to a computer, which is itself connected to the intranet.**

Data management parameters are accessible via the key  of the main page that you can access at any time by pressing the key  of your control panel.

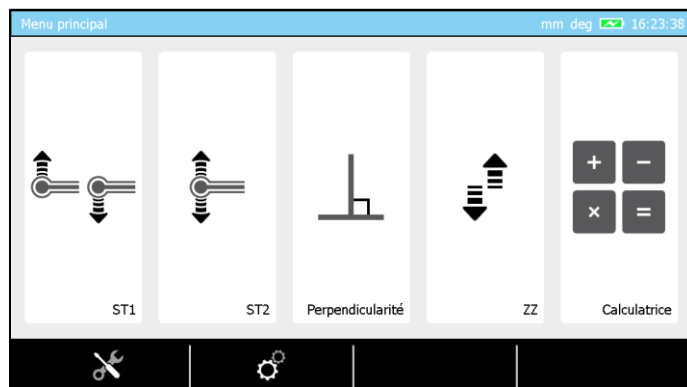

Main page

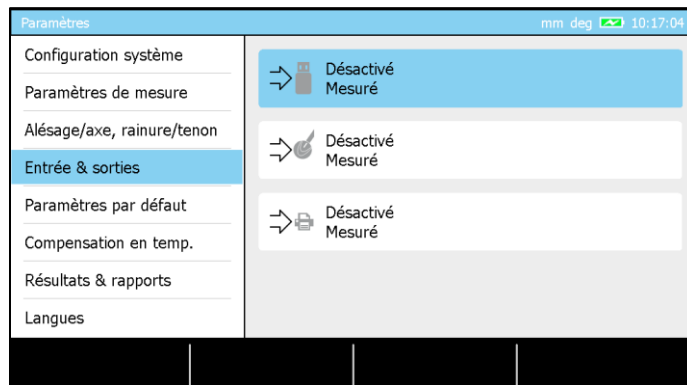

Parameters for data management

21.2 Automatic or manual transmission

Each data management is independent from the others. Therefore, if you choose an option (for example sending data to a USB key), you will have the following possibilities:

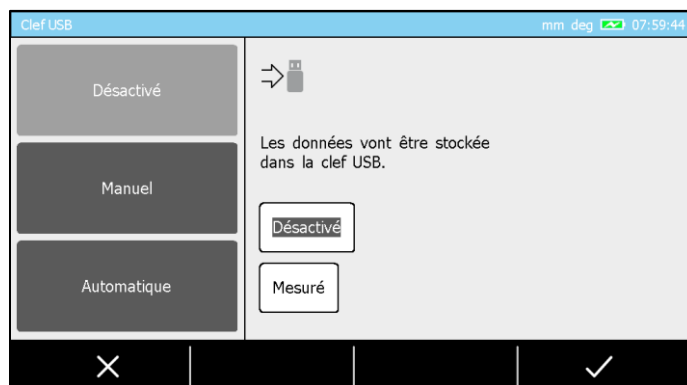

Option	Description
Manual	No value will be sent to the selected device unless the user presses the key  of the control panel.
Automatic	All measured values entered into the measurement list are automatically sent to the device.

When the manual data management option has been selected, it is possible to choose either to send the last block value or, in one batch, all values stored in the measurements list. This is only valid for storing data into the USB key or sending data through the TLC connector.

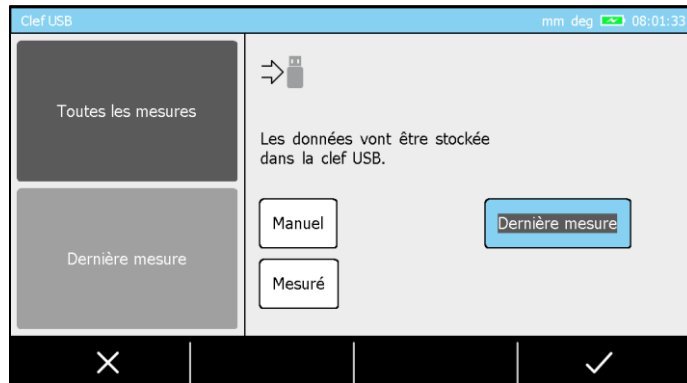

21.3 Transmission format

When you have activated one of the options (sending to USB, sending to TLC or sending to printer), it is also possible to define the format in which you would like to receive the data.

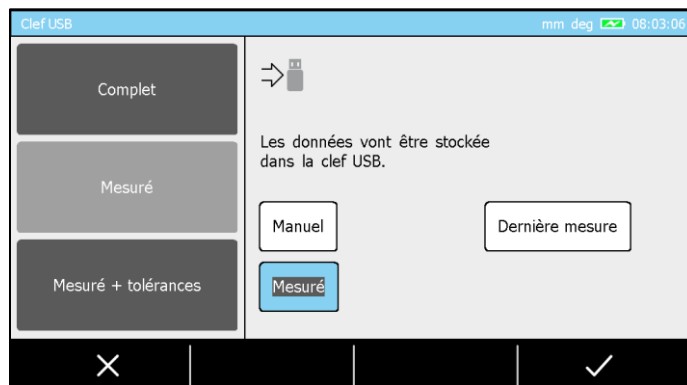

There are currently three available formats:

Option	Description
Complete	<ul style="list-style-type: none"> • Block number • Editable block name • The description of the block (example: down probing, ...) • Measured value • Nominal value • Lower tolerance • Upper tolerance • Deviation • Unit • Date • Time
Measured	Only the measured value is sent
Measured + tolerances	<ul style="list-style-type: none"> • Measured value • Nominal value • Lower tolerance • Upper tolerance

21.4 Transmission via TLC (cable)

Sending data via the TLC port to a computer requires the use of a data transmission cable type TLC-USB (TESA reference: 04760181). This cable has a length of 2 meters.



The use of such a cable requires the prior installation of a driver on your computer.

For further information, please refer to the instruction manual provided with the cable or contact your local reseller.

Once the cable is correctly connected at the back of your panel and to your computer, there are several ways to manage the data: by using additional software such as TESA STAT-EXPRESS or TESA DATA-DIRECT or simply by sending the data to your computer via an application type *HyperTerminal*. For further information, please contact your local reseller.

The connection data is:

Data rate	4800
Parity	Even
Data bits	7
Stop bits	2

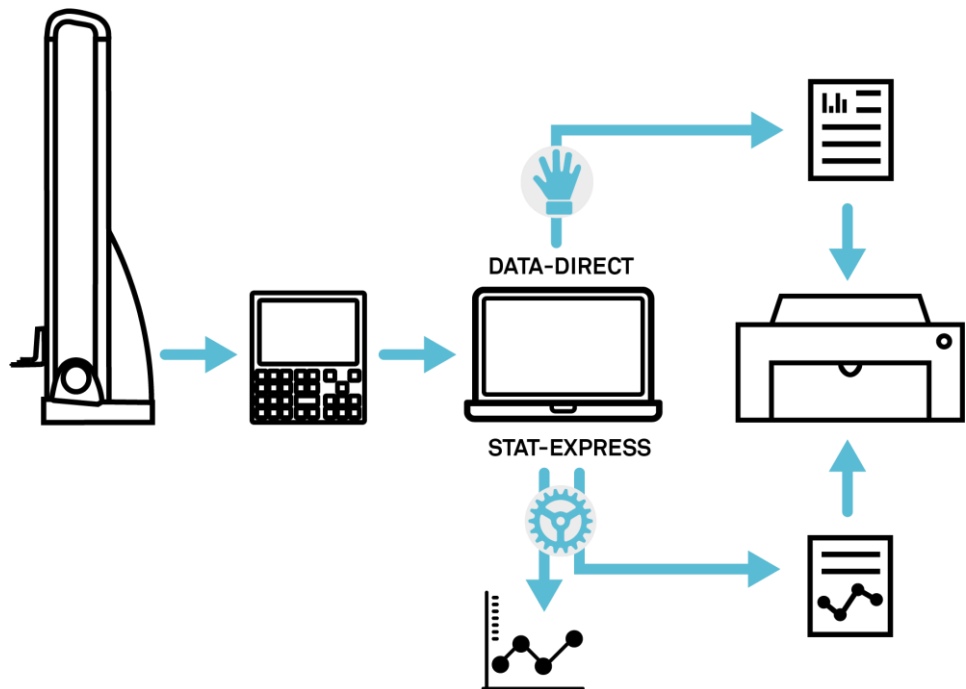

21.5 Transmission via TLC (wireless)

It is also possible to send the data to a computer via the wireless TLC connection. Therefore, it is necessary to use a TLC plug (TESA reference: 04760180) as well as the TWIN-Station receiver box (TESA reference: 05030012)

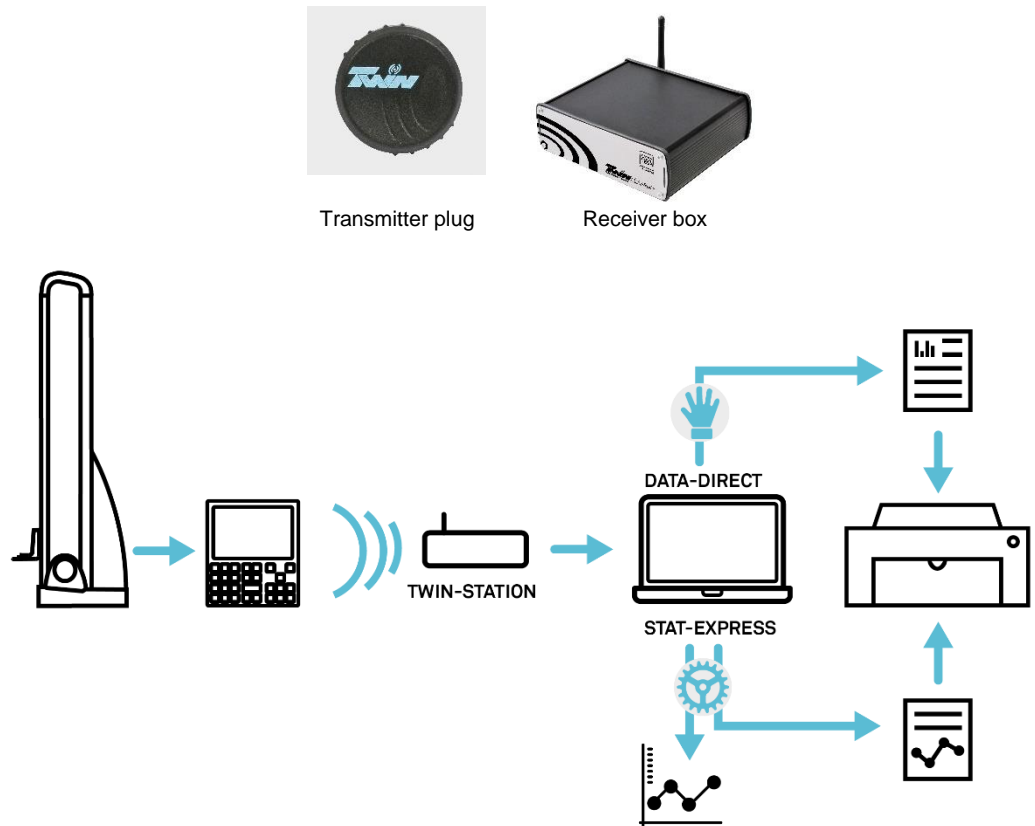

The procedure for configuring such a system is not described in this document. For more information please refer to the document about the system for wireless data transmission or contact your local dealer.

21.6 Use of the printer

When using the printer, only the “measured” format is available. Here is an example of data be printed:

R1	A			
M2	A	⋮	↔	11.207 mm
M3	A		↔	23.069 mm
M4	A	△	↔	23.725 mm
M5	A		↔	-0.656 mm
M6	A	⋮	↔	11.211 mm
M7	A		↔	23.241 mm
M8	A	∅	↔	24.059 mm
M9	A		↔	-0.818 mm
M10	A	⋮	↔	-9.815 mm
M11	A		↔	0.182 mm
M12	A		↔	19.992 mm
M13	A		↔	-19.811 mm
M14	A	⋮	↔	108.186 mm
M15	A		↔	119.179 mm
M16	A	△	↔	21.987 mm

21.7 *.Pdf report

With the MICRO-HITE or MICRO-HITE+M height gauge, reports in *.pdf format can be created on the USB key connected to its panel. The creation can be done:

- automatically after the execution of a measurement programme
- manually when the user selects the action to create the *.pdf file in the context-based action bar

The user can define the process for the report management from the system options menu.

Header

The measurement report has a header containing the following information:

What	Note
Operator's name	Is editable in the system options menu
Company name	Is editable in the system options menu
Part name	The program name is used as the part name
Batch name	Is editable in the system options menu
Date	-
Time	-
Company logo	The file named <i>company_logo.jpg</i> stored in the root folder of the USB stick is taken into account. The company logo is not compulsory. If the panel does not find any logo when creating the document, the area dedicated to the header will be automatically adjusted.

Image of the part

The image of the part can be inserted at the beginning of a measurement report. As for the company logo in the header, the software will check when creating the document, if a file corresponding to the executed program exists at the root of the USB key. If this is the case, the image will be taken into account, otherwise the document will be adjusted accordingly.

Please note that the system is flexible. Indeed, it is possible to have several programs stored on the USB key and for each program a different image to display on the measurement report.

An image must bear the same name as the program to be taken into account when creating a *.pdf measurement report at the end of the sequence execution. Here are some examples:

Name of the program	Name of the image stored in the root folder of the USB key
Piece_TESA.st1	Piece_TESA.jpg
test123.st2	test123.jpg

Sample report:

RAPPORT DE MESURE

Opera...	opérateur 4	Nom	exemple	Date	16/08/2017
Entreprise	TESA SA	Lot	lot 15	Heure	17:52

N°	Caractéristiques	Mesuré	Nominale	Tolérance supérieure	Tolérance inférieure	Etat
M3		28.047	28.05	0.005	-0.005	
M4		49.057	49.06	0.004	-0.004	
M5		9.891	9.9	0.006	-0.006	
M6		28.053	28.05	0.008	-0.008	
M7		70.056	70.06	0.009	-0.009	
M8		49.052	49.06	0.01	-0.01	

votre partenaire de métrologie
1/1

21.8 Annotate a measurement program



















When running a measurement program created by a third person, it is often convenient to be able to rely on explanations or notes made by this person. To do so, it is possible to create on the USB key, a document in *.pdf format describing the program currently stored on the panel and giving the possibility to annotate each of the measurement blocks of that program.

It is possible to generate this document on a USB key from the program management screen.

Programme							mm deg	17:58:56
	Élément		Nominale	+ Tolérance	- Tolérance	Déviaton	Etat	
P1	4.990							
R2	Référence							
M3	28.047		28.05	0.005	-0.005	-0.003		
M4	49.057		49.06	0.004	-0.004	-0.003		
M5	9.891		9.9	0.006	-0.006	-0.009		
M6	28.053		28.05	0.008	-0.008	0.003		

Simply press the context-based action corresponding to the *.pdf document to generate the document on the USB key.

Sample annotation document:

PROGRAMME DE MESURE	
Bloc	Note
P1 4.990  	
R2 Référence  	
M3 28.054  	
M4 49.063   	
M5 9.902   	
M6 28.052  	
M7 70.060  	
M8 (M3 + M7) / 2 49.057   	

1/1

21.9 Screenshot

In order to simplify the creation of personalised procedures, sharing knowledge and training employees, it is possible to take a screenshot at any time.

It is necessary to connect a USB key at the rear of the control panel and to maintain the key  pressed for approximately 3 seconds until a validation beep is generated.

 **It is possible that the control panel does not detect the USB key if the time between the connection of the key to the panel and the screenshot is too short. The panel needs a few seconds in order to recognise that an USB key has been connected.**

22 PROGRAM MANAGEMENT

22.1 Introduction

Because beyond the simple measurement of a unique part there is often the need to control a batch of pieces that could be either small or big, TESA developed a learning mode that gives the mean to manage in a simple way measuring sequences. Once the program has been run, general information of the piece status is automatically displayed on the panel screen.

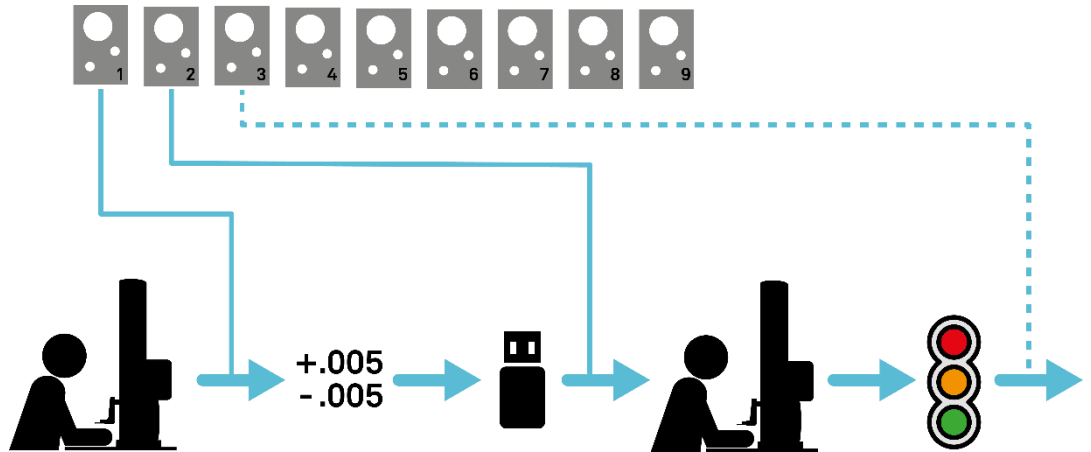

22.2 Program creation

The programming principle by learning means the creation of a measuring sequence on an arbitrary piece (from a batch or not). These measuring sequences can be realised either from ST1 or ST2 mode.

The part that is used to create the measuring sequence is not to be considered as reference part. It is only the mean to define the steps of the sequence by measuring feature after feature on it.

In fact, each block from the measurements' list corresponds to a step of the measuring sequence that can be executed later. This means that all measurements' list corresponds to a potential measuring sequence.

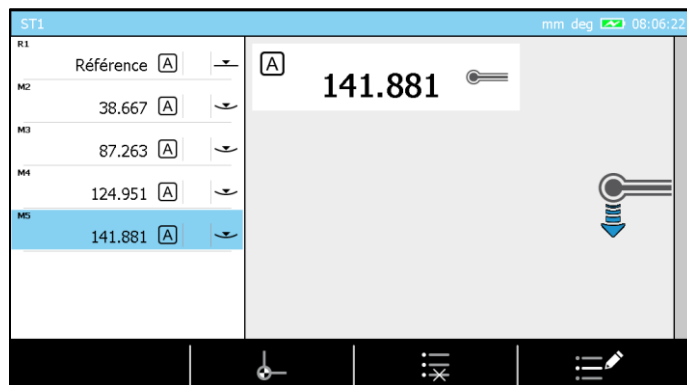

For instance, this memory of 5 blocks defines a 5 steps measuring sequence.

22.3 Insert tolerances

The tolerance management implies that measurement blocks are in memory. Without blocks, it is not possible to insert tolerances.

Once the sequence has been done in ST1/ST2, press **F_x** button from panel keyboard.



You have now the possibility to choose the option concerning programs management.

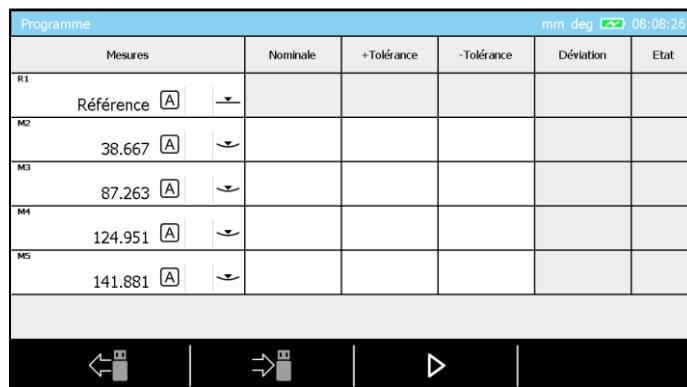

Mesures	Nominale	+Tolérance	-Tolérance	Déviation	Etat
R1 Référence					
M2 38.667					
M3 87.263					
M4 124.951					
M5 141.881					

The displayed page corresponds to a blocks' list equivalent to the one in memory. With this sequence global view it is now possible to proceed to the tolerancing for all dimensions to be controlled.

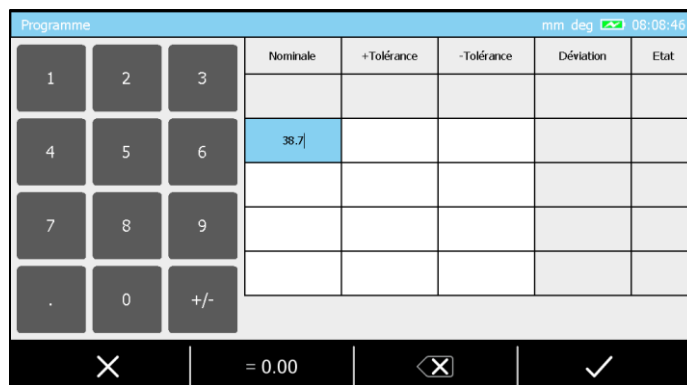

Mesures			Nominale	+Tolérance	-Tolérance	Déviation	Etat
1	2	3					
4	5	6	38.7				
7	8	9					
.	0	+/-					

Inserting a value for this is possible :

- Clicking on the wished square (touch-screen) and enter the value using the panel keyboard
- Double clicking (touch-screen) on the wished square and using the numerical keyboard displayed on the screen
- Selecting the wished square with the panel keyboard arrows and confirming with .

Mesures		Nominale	+Tolérance	-Tolérance	Déviaton	Etat
R1	Référence [A]					
M2	38.667 [A]	38.700	0.500	-0.500	-0.033	■
M3	87.263 [A]	87.300	0.500	-0.500	-0.037	■
M4	124.951 [A]	125.000	0.500	-0.500	-0.049	■
M5	141.881 [A]	141.900	0.500	-0.500	-0.019	■

22.4 Tolerancing with ISO table

In order to use the ISO table to set tolerances it is mandatory to be located in the page dedicated to tolerances insertion.

Mesures	Nominale	+Tolérance	-Tolérance	Déviaton	Etat
F1 2.845 [Ø]					
R2 Référence [A]					
M3 140.830 [A]					
M4 19.902 [A]	19.900			0.002	









Once a nominal value for a diameter has been confirmed, the button is automatically displayed at the bottom of the screen. It allows accessing the following table.

	6	7	8	9	10	11	12	13
D								
E								
F								
G								
H								
JS								

It mean snow only to select the wished tolerance and confirm it in order to load automatically the values for the given characteristic.

22.5 To save a sequence

Once your sequence has been correctly done you can save it into your USB stick. For this, press button from the panel keyboard then select programs management option.

Mesures		Nominale	+Tolérance	-Tolérance	Déviaton	Etat
R1	Référence 					
M2	38.667 	38.700	0.500	-0.500	-0.033	
M3	87.263 	87.300	0.500	-0.500	-0.037	
M4	124.951 	125.000	0.500	-0.500	-0.049	
M5	141.881 	141.900	0.500	-0.500	-0.019	

This page will be displayed. It is now possible to insert tolerances (but not mandatory) then to save the sequence pressing . the next step is to enter the program name and confirm it to end the process and save the data in the USB stick.





 A sequence that has been done in ST1 mode will be saved with *.st1 format. It is the same for ST2. For this case the *.st2 format will be used.



 On the top right side of the window, the number of still available characters as well as the number of total characters are displayed.

22.6 Sequence loading

Loading a measurement sequence from USB stick does not imply that it will be automatically run. Indeed, the loading only recalls the sequence and places it in corresponding memory (ST1 or ST2).

 The blocks from the memory are automatically overwritten when loading a program from the USB stick. It is not possible to get these blocks back.

A sequence can be recalled whenever from ST1 or ST2 mode pressing  from control panel then selecting the programs management option.

 Prior to load a ST 2 sequence from your USB stick, it is not mandatory to have your probe being calibrated. You can directly access the program management options from the probe calibration page pressing  button.

Mesures		Nominale	+Tolérance	-Tolérance	Déviaton	Etat
R1	Référence					
M2	38.667	38.700	0.500	-0.500	-0.033	
M3	87.263	87.300	0.500	-0.500	-0.037	
M4	124.951	125.000	0.500	-0.500	-0.049	
M5	141.881	141.900	0.500	-0.500	-0.019	

Once this page is being displayed, press , select the wanted program from the list and confirm your selection.

Sélection de fichier	
Programme 1	Sélectionner un fichier et presser .
Programme 2	
Programme 3	

When recalling a program, you will have access to a programs' list corresponding to the sequences saved into your USB stick. If you want to recall a program from ST1 mode, the list will only show programs with *.st1 format. It is the same recalling a *.st2 sequence from ST2 mode.

Once a sequence has been loaded in memory, it can be either modified or run in loop.

22.7 To run a sequence

Running a sequence requires blocks in memory. These blocks can either come from a program that would have been loaded from your USB stick or simply from measurements performed without any prior saving.

Once you are sure your program in memory is the one you want, press button from panel keyboard and select the programs management option.

Mesures		Nominale	+Tolérance	-Tolérance	Déviaton	Etat
R1	Référence					
M2	38.667	38.700	0.500	-0.500	-0.033	
M3	87.263	87.300	0.500	-0.500	-0.037	
M4	124.951	125.000	0.500	-0.500	-0.049	
M5	141.881	141.900	0.500	-0.500	-0.019	

Insert tolerances if needed and start the process pressing .

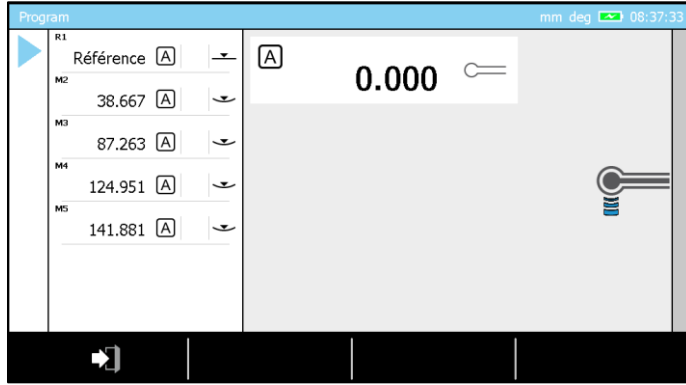

When running a sequence a  icon is displayed on the left of the screen. It represents the current measurement step in the program and inform the user of the block that is currently run.

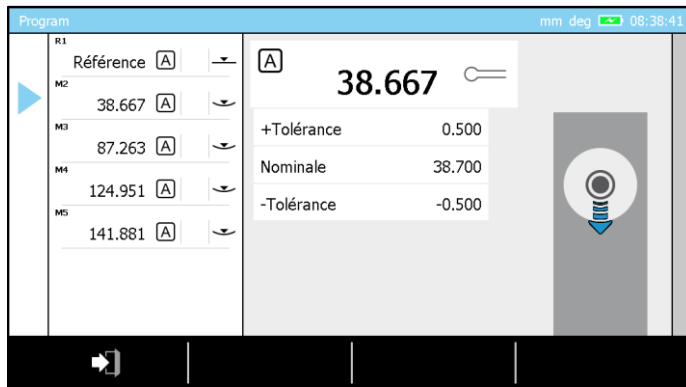

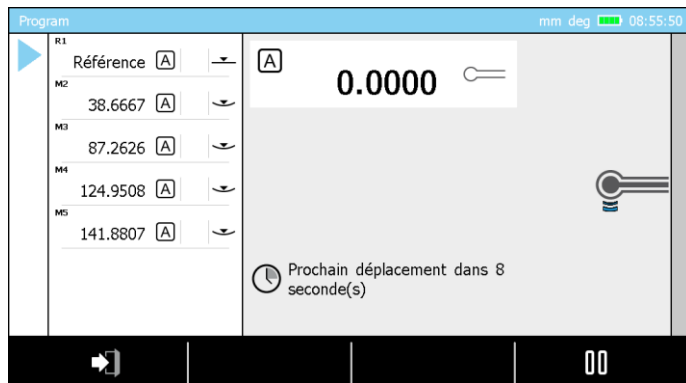

When using a MICRO-HITE+M, a time countdown is also displayed (the time is editable from system options menu). It is the mean to know the remaining time before the next probe displacement and let the user avoid any crash of the probe with the part to be measured.



22.8 Pause a sequence run

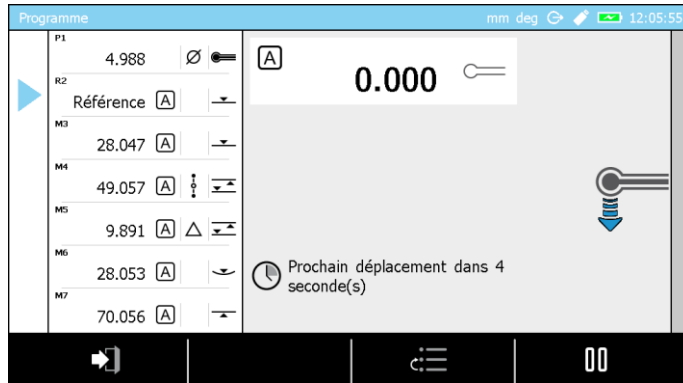

When a measurement sequence has been started, it can be paused at any time by pressing the context-based action .



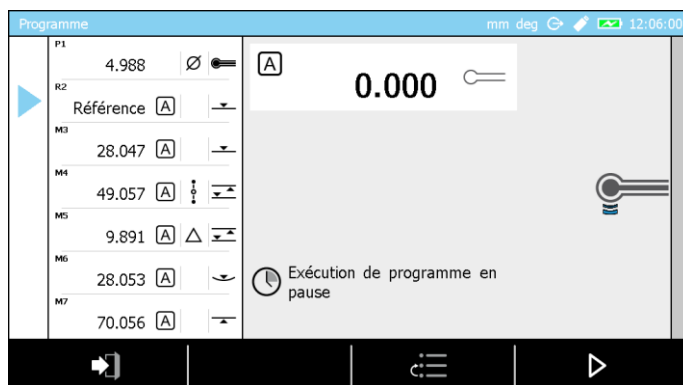

Once the sequence has been paused, it can be continued by pressing the context-based action .



22.9 Remeasure a block

When running a measurement sequence it is not uncommon to wish to measure again the dimension that has just been measured. This is possible by pressing on the  context-based action. The light blue cursor  will then reposition on the previous block to allow its re-measurement.

 It is possible to go several blocks back by repeatedly pressing the context-based action .

22.10 Waiting time (timer)

When running a measurement sequence with a motorized MICRO-HITE+M, it is important to give the operator time to position the probe, so that it does not strike the workpiece when moving to the next measurement zone.

To do so, the operator can enter the desired number of seconds before moving the key in the system options menu.

This timer will be used before moving to a measurement zone or before any measurement.

If the user inserts the value 0 as a timer value, he must manually confirm the movement to the next block in the entire measurement sequence by pressing the  action.

Below, you can find a sample sequence to understand the sequence recall moments during which the countdown will be used.



1

The probe is inserted into the groove manually by moving the part or the instrument



2

A probe hit has the effect of starting a countdown until the probe will be moved to the next measurement zone.

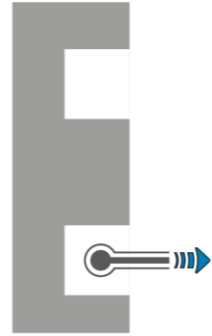

3

During the countdown, the operator has time to withdraw the probe from the part to avoid any subsequent collision.



4

The countdown is finished, the probe automatically moves to the next measurement zone



5

The probe has stabilised at a height close to the measurement, a new countdown was started

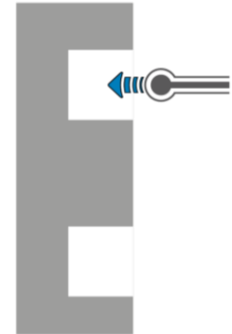

6

During the countdown, the user can position the probe appropriately over the area to be measured



7

The probe is now in a good position, the countdown is not finished



8

Once the countdown is at 0, the probe goes down to measure a point



If the distance between two measurement zones (two measurement points) is small enough, only one countdown will be used in order to save time.

22.11 Results

Once you have run a sequence and reached the end of it, a result page is automatically displayed.

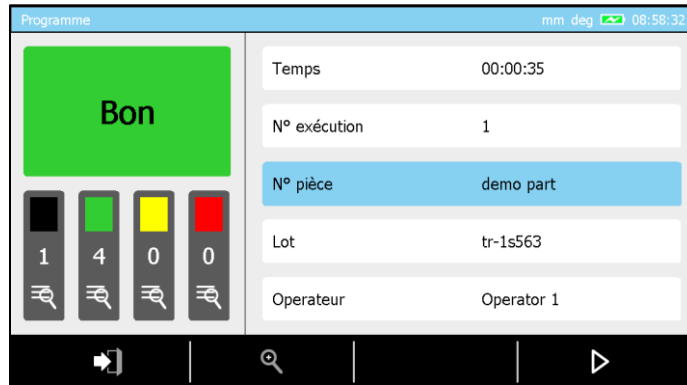



You'll find on the page :

- Part status
 - Good
 - Not good
 - Program end (if the sequence does not include any tolerances)
- The number of
 - Measurements in black (measurements whose tolerances have not been entered)
 - Values in tolerances in green
 - Values to be reworked in yellow
 - Values out of tolerances in red
- Run time
- Run number
- Part name (corresponding to program name)
- Batch name
- Operator name

It is possible to filter the result values by status. To do so, press one of the  button. It will display only the corresponding values having the same status (all good, all bad or all having to be reworked).

22.12 To run a sequence in loop

Once the end of a sequence run is reached, the global results page is displayed. You can either re-run the same sequence from this page using  option or exit the process with .

22.13 Calibration block and execution in a loop

A sequence that has been done from ST2 mode will, most of the time, include a probe calibration block as first block. When running a sequence having such block as first one (if there's no other probe calibration block in the same sequence) running the sequence for the second time will imply that the calibration block won't be taken into account.

22.14 Reference block and execution in a loop

If a measurement sequence takes only one reference (a single reference block) into account during its execution, the software will offer you two ways to manage it:

- Measuring the reference at each run of the sequence
- Measuring the reference only at the first sequence run. This reference is kept in memory for future executions (under the condition of not leaving the sequence execution mode).

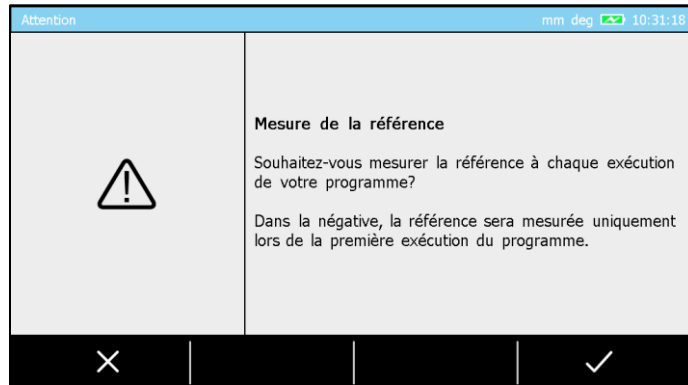

23 CONTROL AND UPDATES

23.1 Generality

As a user, you have the possibility to access certain options that enable a quick control of analysis of your system.

The control options are available in the service menu via the context-based action available on the main page of the software that you can access at any time by pressing the key of your control panel.

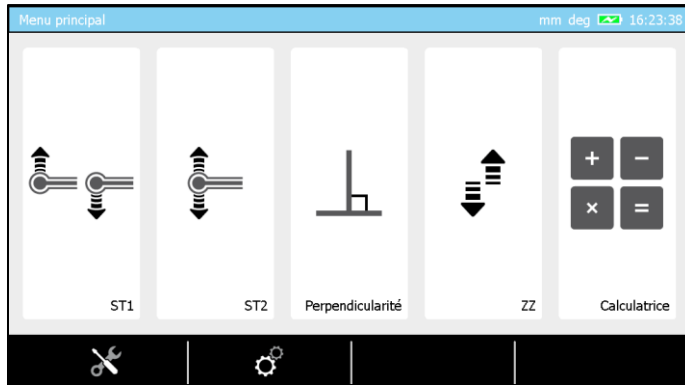

23.2 System information

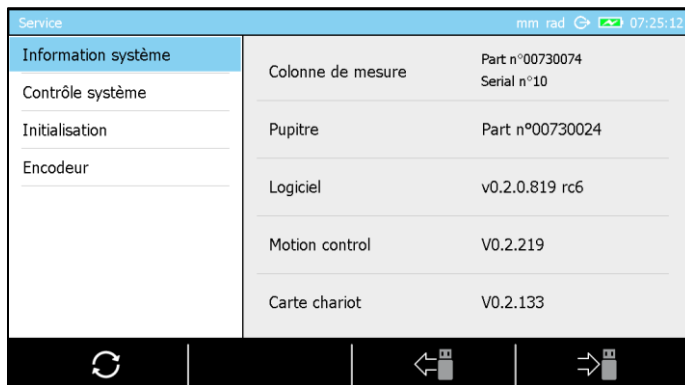

The first tab of the mode gives you an overview of the configuration of your height gauge. You can get the configuration information of your height gauge by pressing the button . A text file that represents the current configuration will be created on your USB key. This configuration can be loaded onto the panel later from the USB key via the button .

When the system options have to be modified according to certain types of applications, it is an advantage to be able to recall a configuration previously stored on a USB key, so that you do not have to manually modify the parameters.

23.3 Control of the system

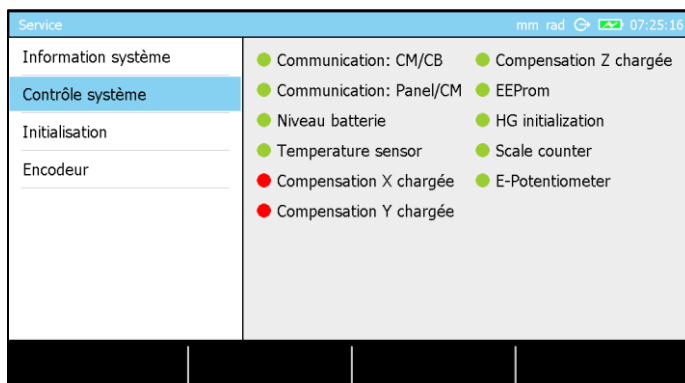

This page of the software enables the visualisation of certain crucial parameters of the system in order to quickly determine the status of the instrument.

23.4 Sensor control

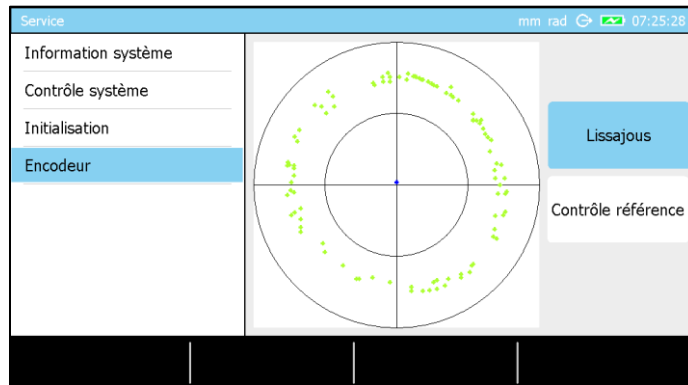

In order to verify the sensor and its positioning regarding the measurement scale, make sure to activate the option “Lissajous” on the right side of the screen. You should then see a circle appear on the screen, as shown in the above picture. In order to control the sensor of your instrument, you only have to move your probe slowly up or down (avoid moving to the end stop), which will lead to the display of green points on the screen. A sensor has been correctly configured when you see a centred circle appearing.

23.5 Reference mark control

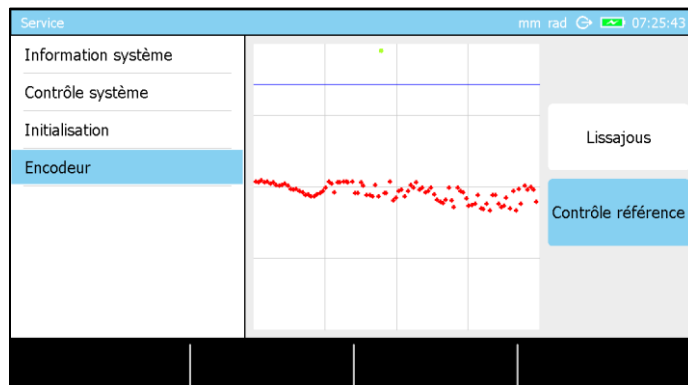

On this page, the option “reference control” has to be activated first. Then slowly move the probe up or down. It is the same principle as the initialisation of the height gauge after turning on the instrument. The encoder has to pass in front of the control mark defined on the scale (at a height of approximately 15 cm from the base). If the mark is detected, a beep is generated and a green point is displayed on the screen.

23.6 Software update

For the following procedure it is supposed that you already have the file that corresponds to the software version that you would like to load onto your instrument. If you do not have this file, please contact your local reseller.

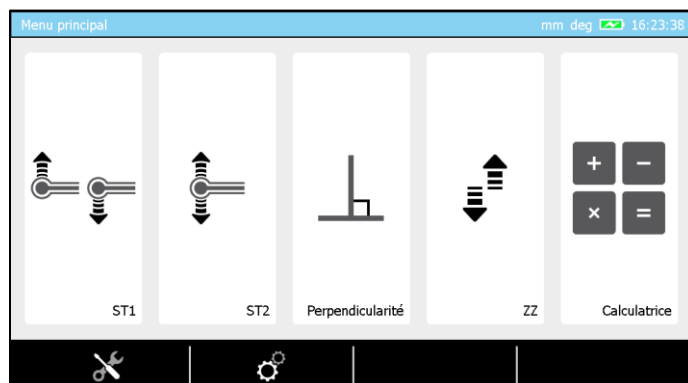

1. Press the key  in order to go to the main page of the software.

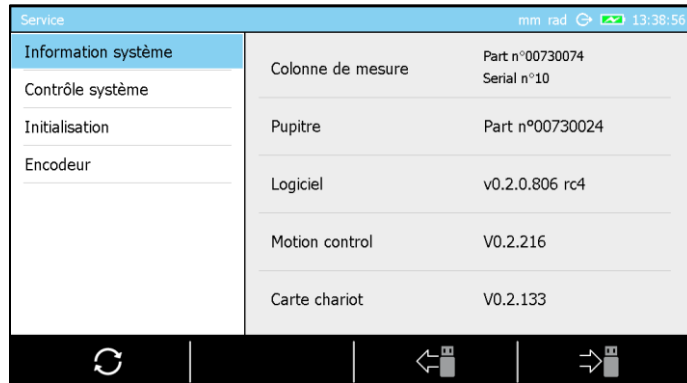

2. Enter the service mode by clicking on the context-based option .



3. Make sure to be on the first page of the mode and to have access to the following option at the bottom of the screen . Click on it.

4. A warning message will automatically be displayed, press on  in order to continue the process or  in order to cancel it. If the process is not cancelled, the software will automatically close the application and open a special service mode.

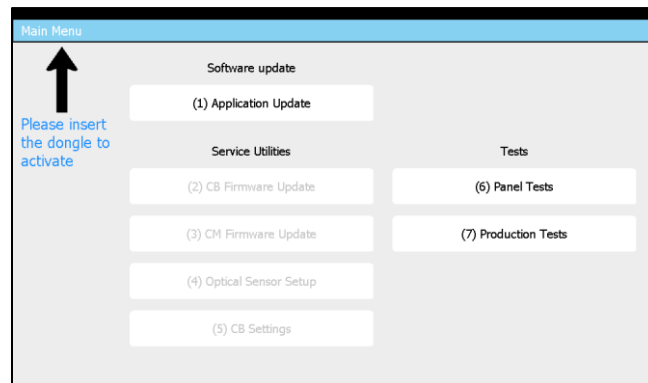

5. Make sure that the software file has correctly been copied to the root folder on the USB key that you now have to connect to your control panel.

6. Press the button “1” of the numerical keyboard or click on option “Application Update” on the screen.

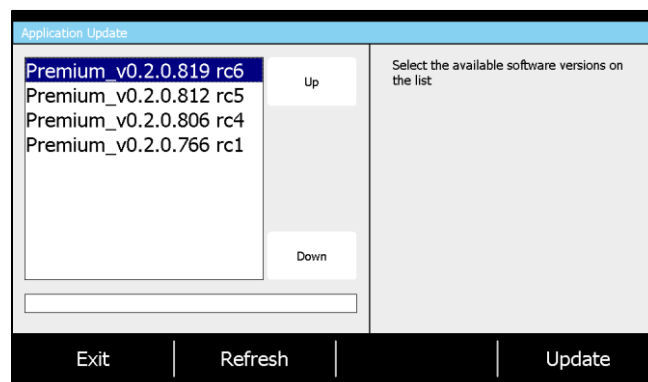

The software will list all available versions on your USB key and displays them in chronological order with the most recent one at top of the list. In the case above, the USB key contains 4 different software versions.



















7. Once you have chosen your version, click on the button “Update”. The software will be installed (this can take several minutes) and then warn you that the control panel will automatically shut down.
8. Wait until the control panel is automatically turned off then manually turn it on again.
9. You can now use your height gauge.











Each software version (loaded onto your control panel) is linked to firmware versions used in the electronic cards that are part of your height gauge. When you update your height gauge with a new software version, make sure that the electronic cards do not have to be updated as well, by contacting your local reseller.







24 CONTEXT-BASED ACTIONS

24.1 General actions





Definition	
	Cancel Allows you to cancel the current process or to leave a mode without saving any changes.
	Delete Allows you to delete the selected value.
	Return Allow to come back to the previous page
	Cartesian coordinates Allows to work in Cartesian coordinates.
Deg	Change angle unit Allows you to change the unit of the displayed angles. The new unit is "degree".
	Delete value or letter Allows you to delete the last character entered when manually entering a name or a value.
DMS	Change angle unit Allows you to change the unit of the displayed angles. The new unit is "degree:minute:second".
	Validate Allows you to validate the current process or to leave a mode while saving any changes.
	Edit Allows you to edit the name of a selected measurement block in the memory.
	Pause Allows you to pause the active process
	Execution Allows you to start a measurement process or restart it in case it was paused before.
	Polar coordinates Allows you to work in polar coordinates.
	Change graph Allows you to change the type of graph displayed when measuring culmination points.
Rad	Change angle unit Allows you to change the unit of the displayed angles. The new unit is the "radian".
	Recall Allows you to recall a file from the USB key.
	Cancel last measurement Allows you to carry out the last measurement in the memory again.
	Save Allows you to save on the USB key.
= 0.00	Zero setting Allows you to quickly set the selected value to zero.
	Ignore Allows you to avoid certain steps of procedures and to directly access the result.
	Delete block Allows you to delete the last block of the measurement memory.
	Utility services Access to the menu for maintenance of the height gauge as well as access to its information.
	Update Starting update of the selected option.
	System options Access to general parameters of the system.

	Change resolution 1 Allows you to increase the resolution regarding the active display.
	Change resolution 2 Allows you to decrease the resolution regarding the active display.
	Modify angle unit Allow to modify the angle unit. The current active angle unit is degree.
	Modify angle unit Allow to modify the angle unit. The current active angle unit is DMS.
	Modify angle unit Allow to modify the angle unit. The current active angle unit is radian.
	Select Allows you to select all the blocks of the memory
	Deselect Allows you to deselect all the blocks of the memory
	Delete Allows you to delete all the blocks previously selected in the memory
	*.pdf document Creation of the *.pdf document on the USB stick.

24.2 Actions regarding ST1 & ST2 modes

Definition	
	Redefine reference Allows you to restart the process to define the active reference.
	Leave mode 'recall programme' Allows you to stop the current measurement programme (programme recall)
	Calibration of the insert with groove Allows you to define the calibration process of the insert by measurement of a groove.
	ISO table Allows you to display the ISO table of tolerances in order to quickly set the tolerances of the selected value.
	Indirect reference (PRESET) Allows you to take into account an offset regarding the active reference, so that you can work with an indirect reference.
	Probe constant Restarts the calculation procedure of the probe constant.
	Calibration of the insert with rib Allows you to define the calibration process of the insert by measurement of a rib.

24.3 Actions regarding Perpendicularity mode

Definition	
	Graph display Once all measurements finished, it is possible to display an overview of the scanning of the workpiece.
	Measurement window in Z Informs you of the range in Z (from the start of the measurement) in which the measurement will be carried out. Once the range has been exceeded, the measurement will automatically stop.
	Modify resolution Allows you to modify the resolution of the ordinate axis (variation of the probe travel) of the graph displayed. Attention, the entered value represents the total range of visualisation. This means that if the value 10 is entered, the displayed range will be -5 to +5.
	Back to measurement Allows you to go back to the measurement page.



















24.4 Actions regarding Angle mode

Definition	
	Gauge block Allows you to manually enter the size of the standard used in order to calculate the angle of a workpiece. This value is stored in the memory as long as the instrument is not turned off.



24.5 Actions regarding *Min, max, Δ* mode

Definition	
	Reference Allows you to take the reference into account in your measurement results or not.

24.6 Actions regarding 2D mode

Definition	
	Angle between two lines Allows to calculate the angle between two selected lines.
	Angle by three points Allows to calculate the angle that make three elements represented either by simple points or circles. A combination of these two elements types is also possible.
	Intersection Allows to create the intersection point between two lines.
	Circle by three points Allows to calculate the perfect circle going through three points, circles or a combination of these two element types.
	Bestfit circle Allows to calculate the best circle from more than three points or circles' centres.
	Line by two points Allows to calculate the perfect line going through two points, circles or a combination of these two elements' types.
	Bestfit line Allows to calculate the best line from three or more points or circles' centres.
	Distance Allows to calculate the distance between two points or circles centres.
	Perpendicular distance Allow to calculate the perpendicular distance between a point/circle and a line.
	Analyse and display results Allows to display measured and calculated data.
	Save result Allows to save a result in the main programme to be run later.
	Y axis as reference Allows to set a line as Y axis datum
	Z axis as reference Allows to set a line as Z axis datum
	Origin Allows to define a point or a circle centre as origin
	Rotate for Y coordinate Allows to rotate the part to measure Y coordinates
	Rotate for Z coordinate Allows to rotate the part to measure Z coordinates
	Coordinate change 1 Switches to Cartesian coordinates
	Coordinate change 2 Switches to polar coordinates

24.7 Actions regarding *Calculator* mode

Definition	
	Change memory Allows you to change from memory ST1 to measurement memory ST2 (or vice versa)
	Get function Allows to recall the customised function from a block
	Customised function Allows you to create a customised calculation block with the previous result blocks

OPTIONAL ACCESSORIES:



Battery
00760244



Loading station for battery block
00760245



Power supply
00760251



IG13 adapter cable
00760247



Fine adjustment
00760246



Master piece
00760236



MH panel
00760233
MH+M panel
00760234



Printer
00760235



4 paper rolls for printer
00760250



TLC-USB cable, 2m
04760181



DATA-DIRECT software
04981001



STAT-EXPRESS software
04981002



IG13 probe
00760140



Practice part
00760124



Standard probe support
00760243



Dust cover 350mm
00760151
Dust cover 600mm
00760152
Dust cover 900mm
00760153



Foot switch
04768001



Hand switch
04768000

DECLARATION OF CONFORMITY EU

We thank you for purchasing our product. We hereby certify that it was inspected in our works.

Declaration of conformity and confirmation of traceability of indicated values

We declare under our sole responsibility that its quality is in conformity with all technical data as specified in our sales literature (instruction manual, leaflet, general catalogue). In addition, we certify that the measuring equipment used to check this product refers to national standards. Traceability of the measured values is ensured by our Quality Assurance.

Name of manufacturer	TESA SA
Address of manufacturer	Rue du Bugnon 38 CH – 1020 Renens
Declares under its sole responsibility	
The product	Height gauge: TESA MICRO-HITE TESA MICRO-HITE+M
Type	00730073 MICRO-HITE 350 00730074 MICRO-HITE 600 00730075 MICRO-HITE 900 00730076 MICRO-HITE 350F 00730077 MICRO-HITE 600F 00730078 MICRO-HITE 900F 00730079 MICRO-HITE+M 350 00730080 MICRO-HITE+M 600 00730081 MICRO-HITE+M 900
is in compliance with	<ul style="list-style-type: none">• the directives 2014/30/EC• the standards EN 61326, class B, with disconnected charger• and the continued technical data in our sales documents

Renens, 15 June 2016

Quality Assurance Service

EXAMPLE, TESA WORKPIECE

